

Catálogo de sistema

RM40MN

SISTEMA BATIENTE MALLORQUINA DE CÁMARA EUROPEA

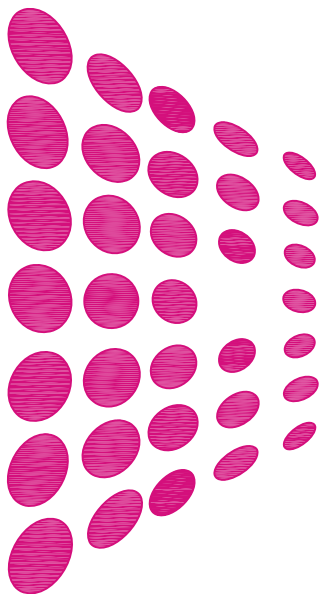

ROMINIO

Servicios y Suministros, S.L.U.

INDICE

1_ Características técnicas del sistema

2_ Relación de perfiles

3_ Accesorios y juntas

4_ Perfiles

5_ Nudos

6_ Hojas de corte

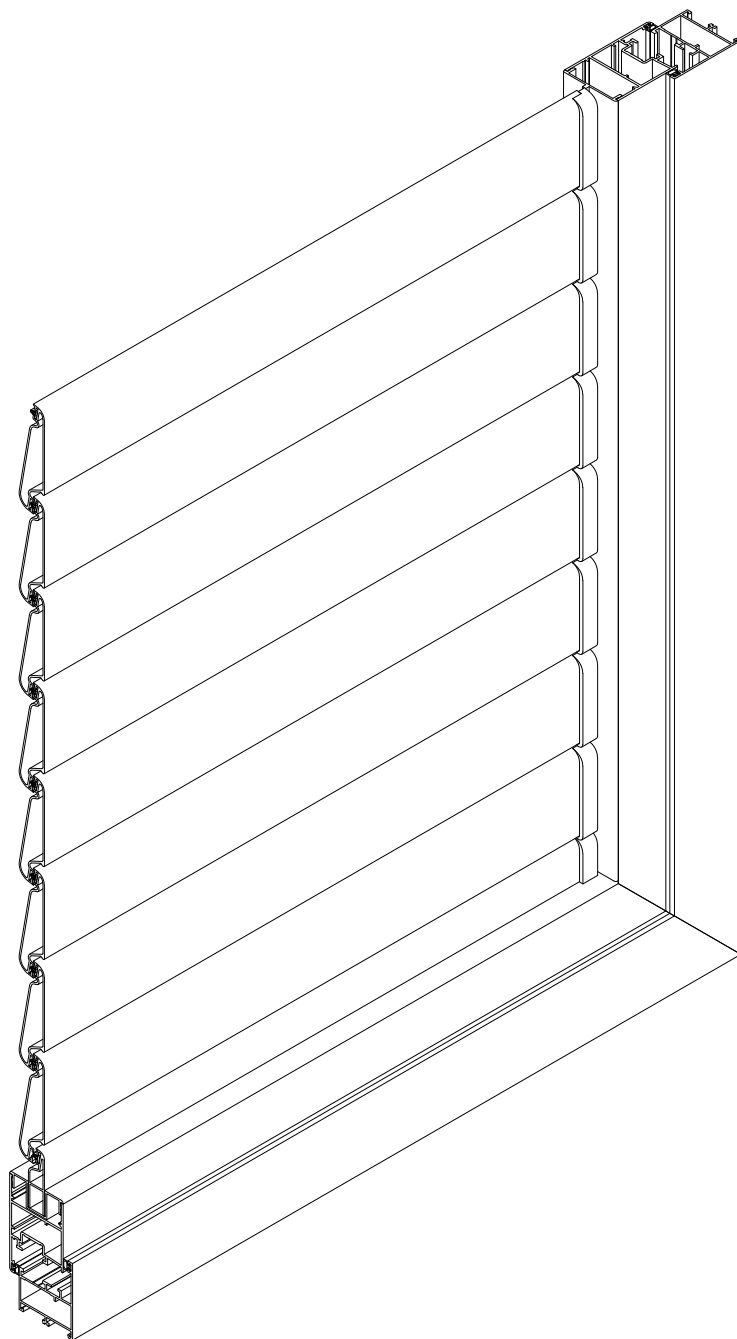

Características del sistema

Sistema batiente mallorquina de cámara europea

Perfiles de aluminio

Perfiles de aluminio extrudidos en aleación 6063 según UNE 38337 o aleación 6060 según UNE 38350 y tratamiento T5. Espesor medio de perfiles de aluminio de 1,5 mm.

Marcos

- Marcos con sección de 40 mm.
- Marcos ensamblados con escuadra de fundición y de alineamiento para la correcta unión de los ingletes.
- Marco con solape directo de 30 mm.
- Opción de acoplar lamas fijas y orientables.

Hojas

- Hojas con sección de 40 mm.
- Hojas de línea recta.
- Hojas ensambladas con escuadra de fundición y de alineamiento para la correcta unión de los ingletes.
- Opción de acoplar lamas fijas y orientables.

Aperturas

- Apertura abatible exterior.
- Posibilidad de realizar ventanas, balconeras y puertas de paso.

Posicionamiento de las lamas

- Mediante mecanismos para lama orientable o piezas de sujección para lama fija.

Estanqueidad

- Doble junta de EPDM





VENTANAS PRACTICABLES MALLORQUINAS ROMINIO RM40MN





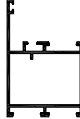

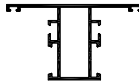
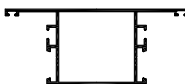
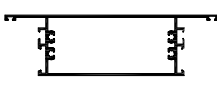
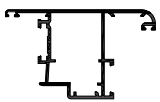
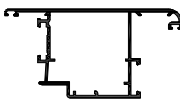
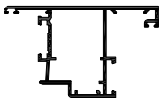

Uds. de ventana o balconera de la serie RM40MN de Rominio con canal europeo de 1 o 2 hojas, realizada con perfiles de aluminio extruido en aleación 6063 según UNE 38337 o aleación 6060 según UNE 38350 y tratamiento T5.

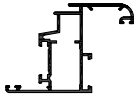
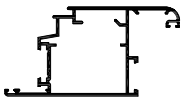

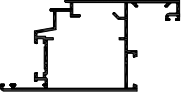
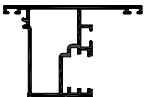

Aluminio acabado anodizado según la marca de calidad QUALANOD, con un espesor mínimo de (15-20-25) micras, color o aluminio lacado según el sello de calidad QUALICOAT con un espesor de la capa de pintura poliéster mínimo de 60 micras color RAL





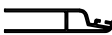

La ventana o balconera está compuesta por marcos tubulares de 40 mm y hojas tubulares de 40 mm, con cortes a inglete unidos con escuadras de fundición de 15, 27 o 40 mm, triple junta en EPDM y accesorios propios de la serie.

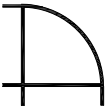
Todo ello según detalles de proyecto, totalmente acabada y rematada y con p.p de medios auxiliares para la realización de la obra.

PERFILES				
Referencia	Diseño	Descripción	Momentos de Inercia	
			Ix (cm ⁴)	Iy (cm ⁴)
4101		cercos de 15 mm	4.07	5.53
4102		cercos de 27 mm	8.30	6.76
4104		cercos de 15 mm con solape	9.22	7.44
4111		travesaño de 72 mm	7.22	6.35
4112		travesaño de 97 mm	9.05	22.08
4113		travesaño de 140 mm	13.99	90.47
4021		hoja curva de 27 mm apertura exterior	14.52	11.04
4022		hoja curva de 40 mm apertura exterior	26.22	13.38
4025		hoja curva de 27 mm recta apertura exterior	14.52	11.04
4026		hoja curva de 40 mm recta apertura exterior	26.22	13.38

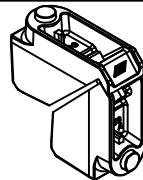
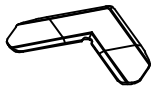
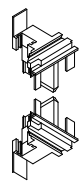
PERFILES				
Referencia	Diseño	Descripción	Momentos de Inercia	
			Ix (cm ⁴)	Iy (cm ⁴)
4121		hoja curva de 15 mm	8.15	9.80
4122		hoja curva de 40 mm	24.70	13.96
4125		hoja recta de 15 mm	8.15	9.80
4126		hoja recta de 40 mm	6.57	9.66
4231		inversor	---	---
P40906		reductor para lama fija	---	---
4201		hoja mallorquina	---	---
4202		cerco fijo	---	---
4211		travesaño de 50 mm	---	---
4213		travesaño de 120 mm	---	---

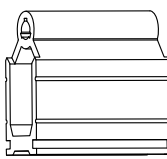
PERFILES				
Referencia	Diseño	Descripción	Momentos de Inercia	
			Ix (cm ⁴)	Iy (cm ⁴)
4221		perfil base en U	---	---
4222		lana compensación de 57 mm	---	---
4223		lana fija ovalada	---	---
4224		lana orientable	---	---
1213		h unión de 40 mm	---	---
4132		esquinero 40 mm curvo 90°	---	---

DISEÑO	REFERENCIA	DESCRIPCIÓN
	0443	escuadra 23.9 x 14 mm montebianco
	0444	escuadra 23.9 x 26 mm montebianco
	0446	escuadra 23.8 x 39.2 mm montebianco
	3714AC	escuadra abierta 37x14 AC (40x18) cerco 4202
	1200	escuadra alineamiento hoja
	INE1903	tapa inversor 4231
	1518	unión europea cerrada de 15 x 18 mm
	4018	unión europea cerrada de 40 x 18 mm
	309.043.TP	junta estanqueidad interior

DISEÑO	REFERENCIA	DESCRIPCIÓN
	331.050.C1	junta lama orientable
	07883	cremona apertura exterior con maneta baja
	2289	grillo TOP para 1 hoja
	2287	grillo MIDI para 2 hojas
	2285	grillo MAXI para 3 hojas
	2291	fijador de ventana a pared
	9686	separador reversible de 40 mm para lama fija ovalada
	9687	terminal M-23 para lama fija ovalada (juego)
	0007	soporte lama fija ovalada 4223 (juego)

DISEÑO	REFERENCIA	DESCRIPCIÓN
	9692D	bisagra 4ª hoja derecha
	9692 I	bisagra 4ª hoja izquierda
	9750	mando ROTARY negro ambas manos

MECANISMOS PARA LAMA ORIENTABLE

Diseño	Código (juego)	Nº de Lamas	Altura Stándar (mm)
	9706	6	460
	9707	7	520
	9708	8	580
	9709	9	640
	9710	10	700
	9711	11	760
	9712	12	820
	9713	13	880
	9714	14	940
	9715	15	1000
	9716	16	1060
	9717	17	1120
	9718	18	1180
	9719	19	1240
	9720	20	1300
	9721	21	1360
	9722	22	1420
	9723	23	1480
	9724	24	1540
	9725	25	1600
9726	26	1660	
9727	27	1720	
9728	28	1780	
9729	29	1840	
9730	30	1900	

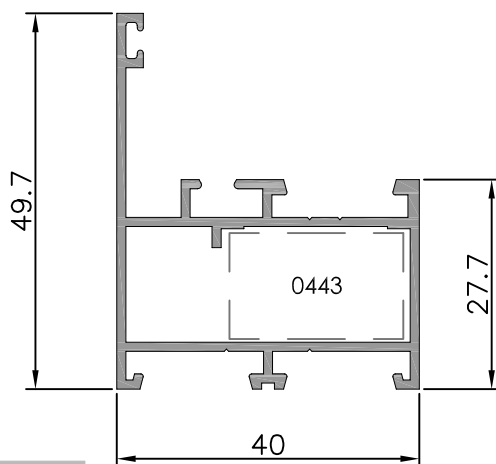

4101

Cerco de 15 mm

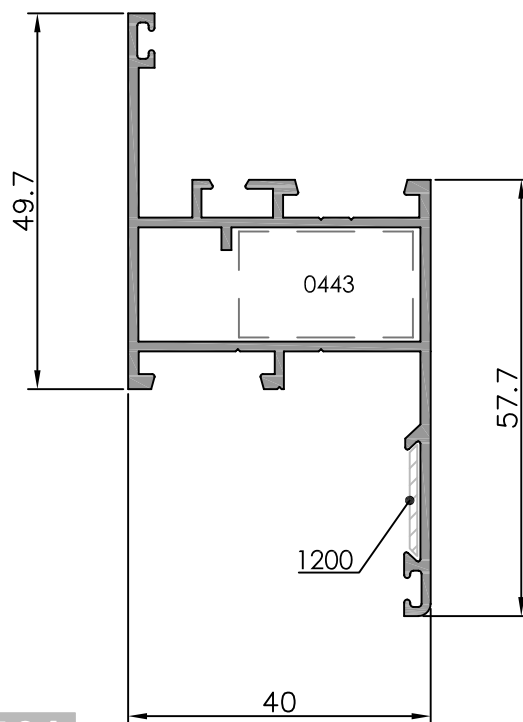

4104

Cerco de 15 mm con solape

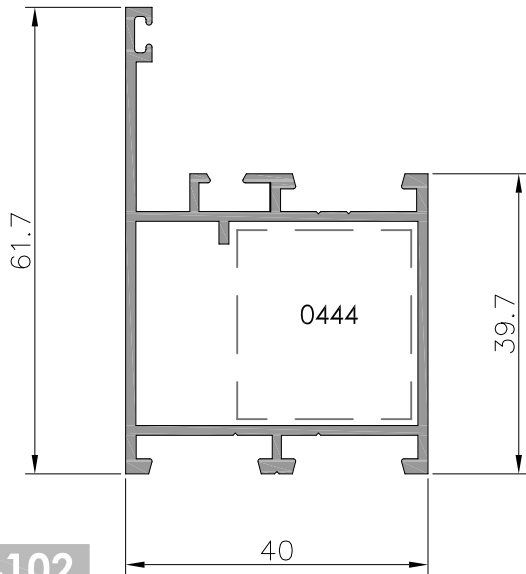

4102

Cerco de 27 mm

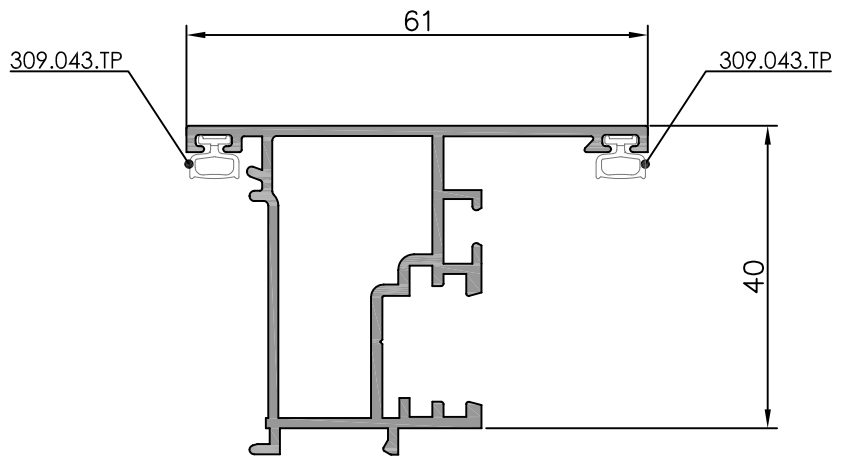

4231

Inversor

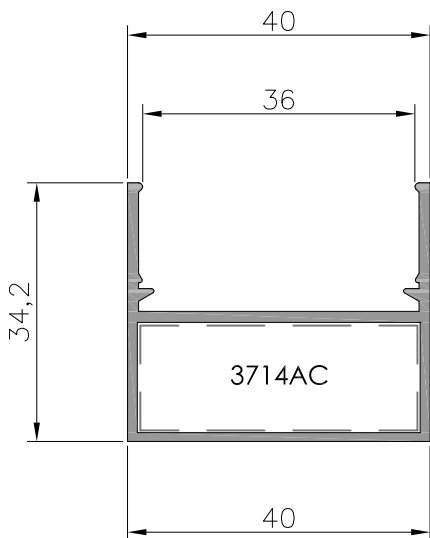

4202

Cerco Fijo

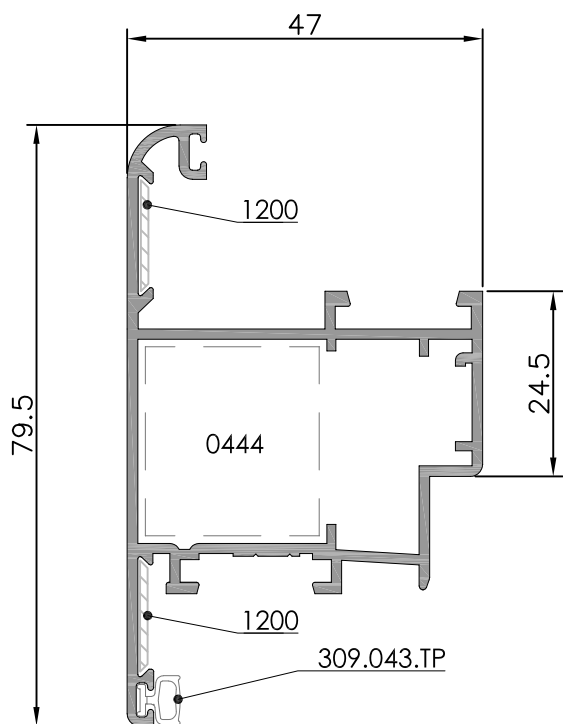

4021

Hoja curva de 27 mm
 Apertura Exterior

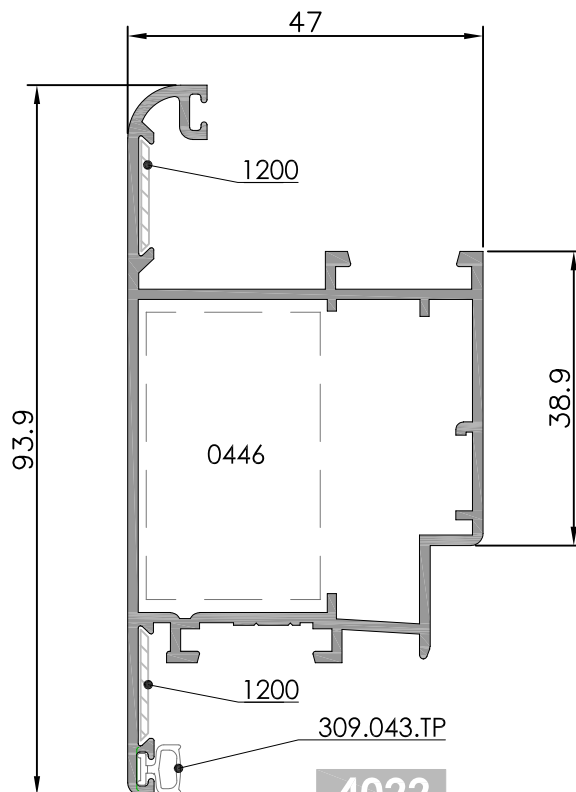

4022

Hoja curva de 40 mm
 Apertura Exterior

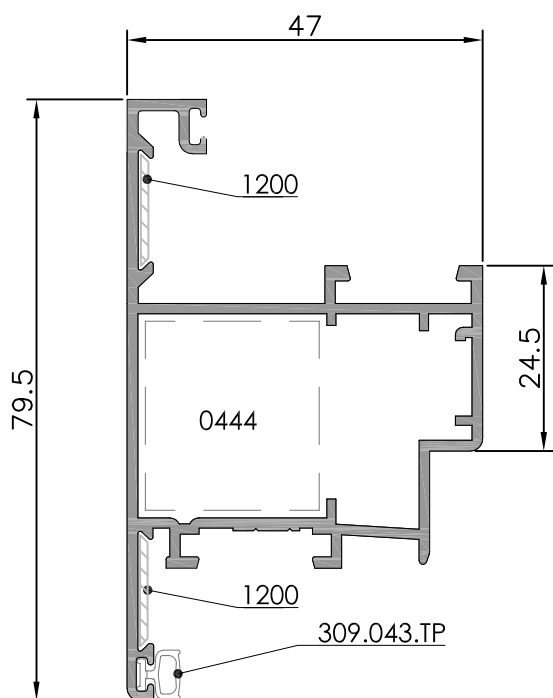

4025

Hoja recta de 27 mm
 Apertura Exterior

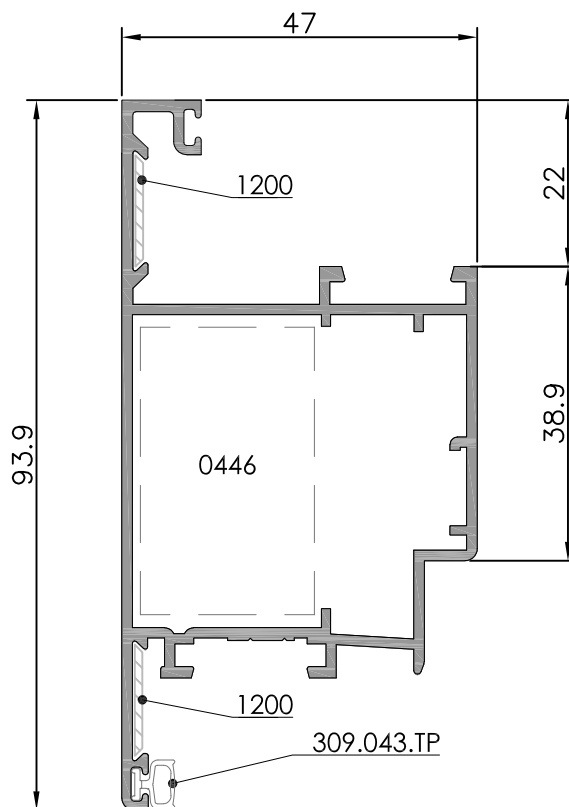

4026

Hoja recta de 40 mm
 Apertura Exterior

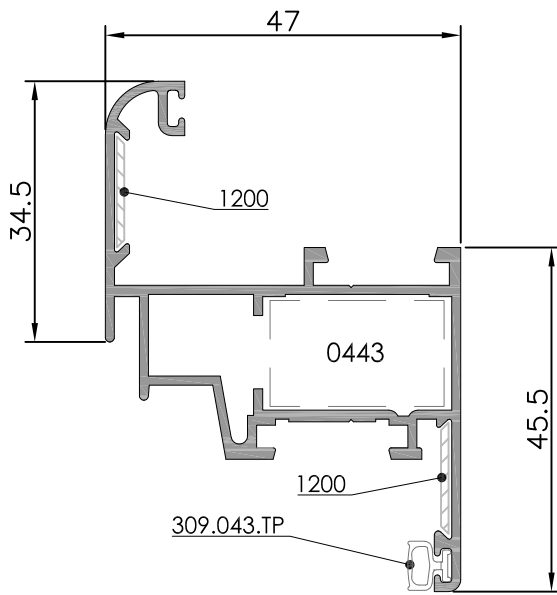

4121

Hoja curva de 15 mm

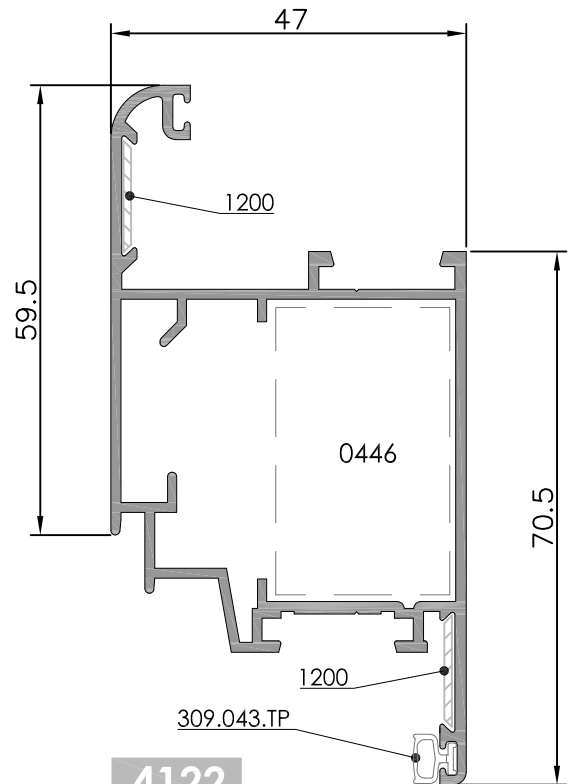

4122

Hoja curva de 40 mm

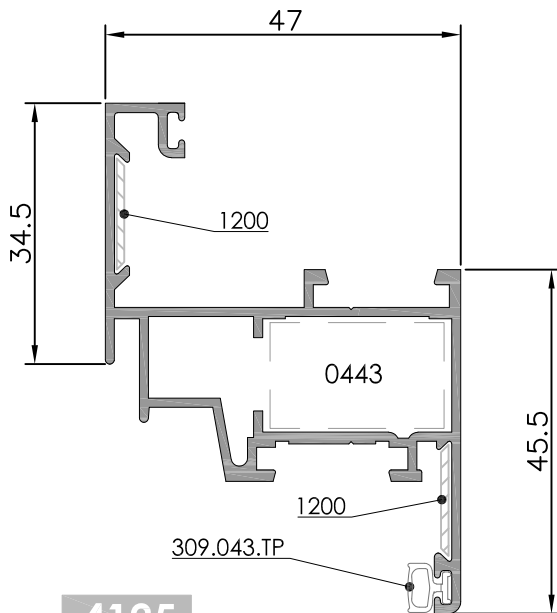

4125

Hoja recta de 15 mm

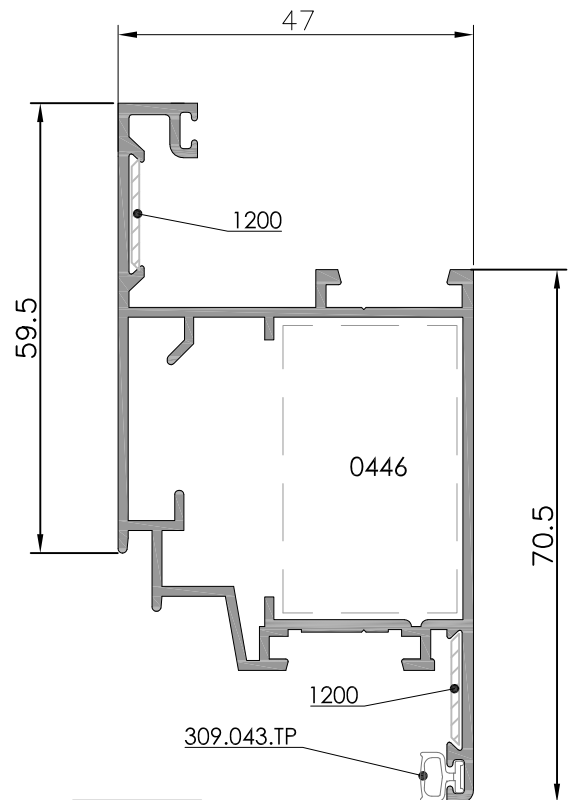

4126

Hoja recta de 40 mm

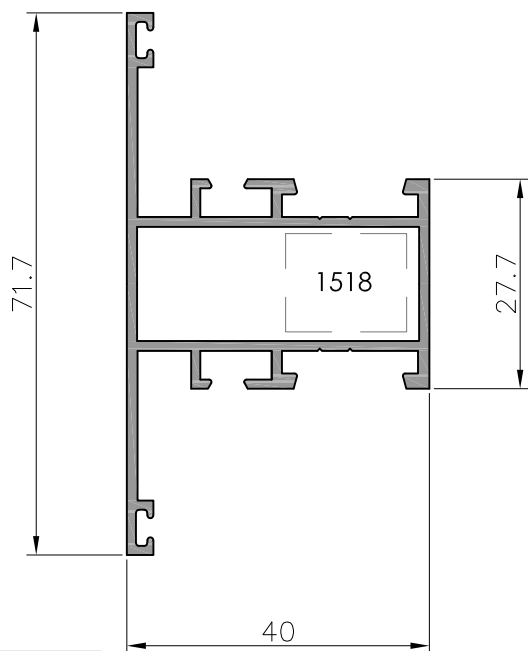

4111

Travesaño de 72 mm

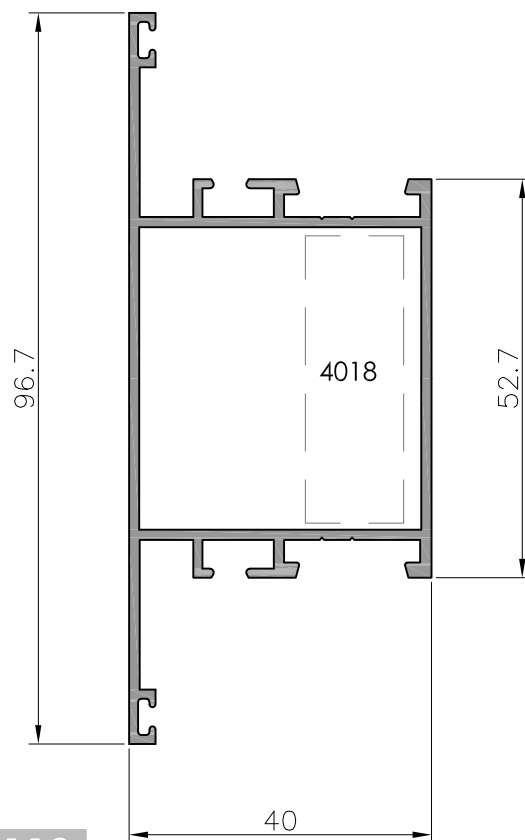

4112

Travesaño de 97 mm

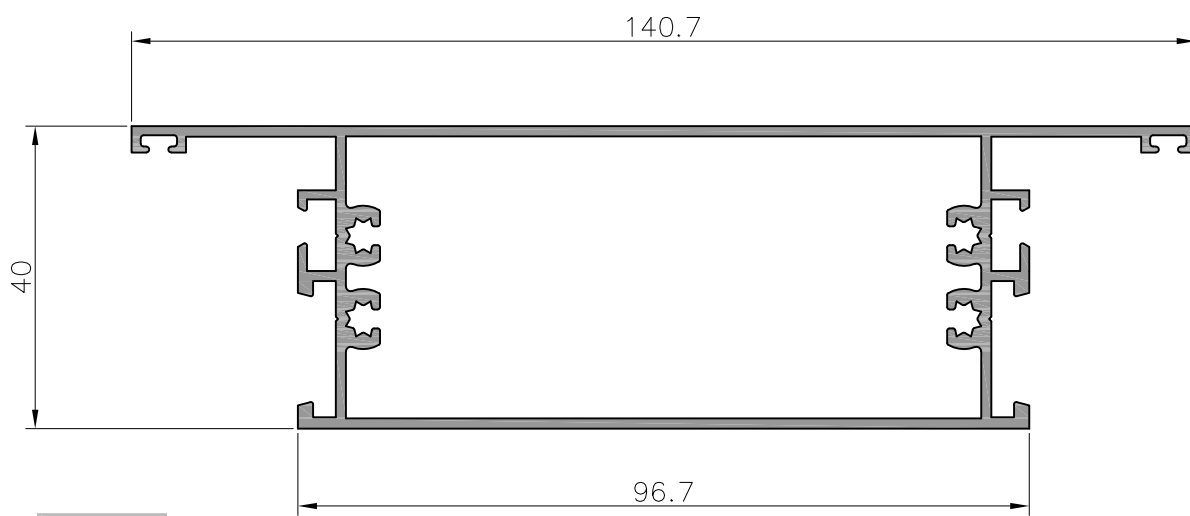

4113

Travesaño de 140 mm

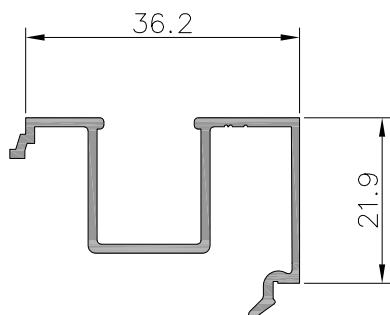

P40906

Reductor para lama fija

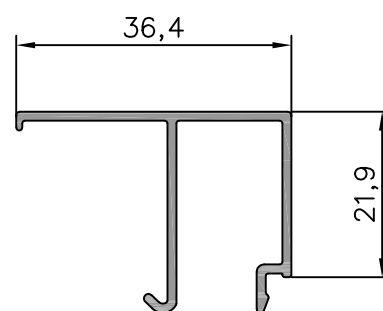

10010

Junquillo de 36.5 mm

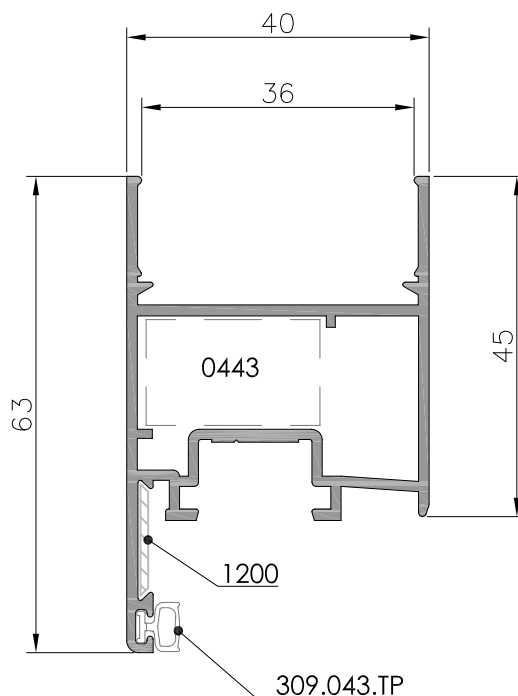

4201

Hoja Mallorquina

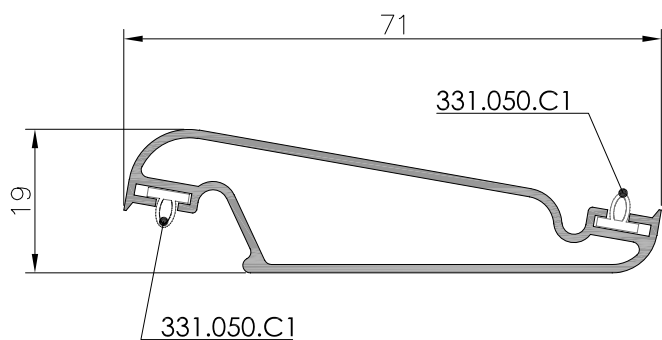

4224

Lama Orientable Perla 70

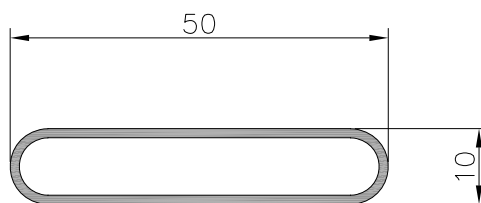

4223

Lama Fija Ovalada

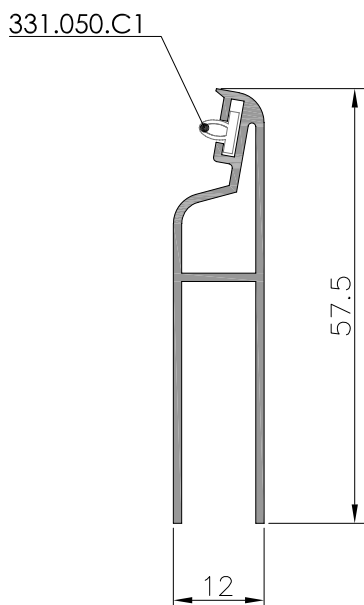

4222

Media Lama de 57 mm

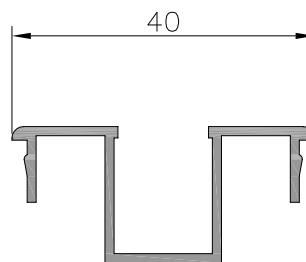

4221

Perfil Base en U

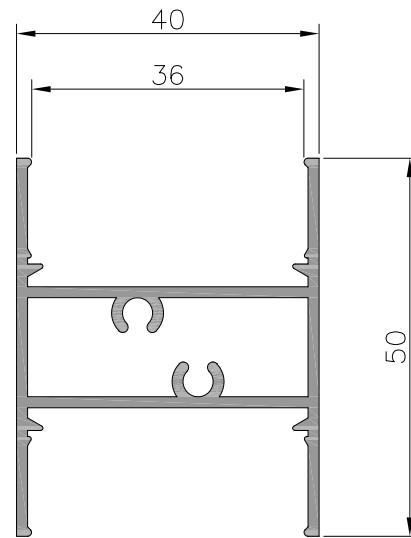

4221

Travesaño de 50 mm

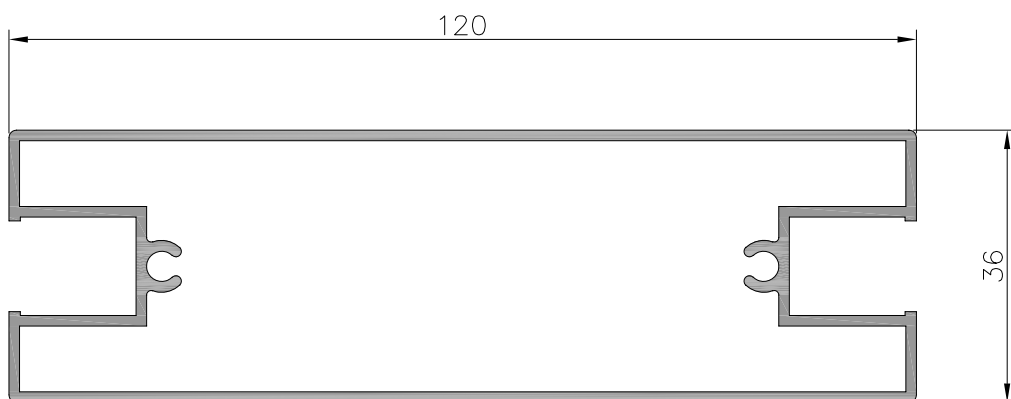

4213

Travesaño de 120 mm

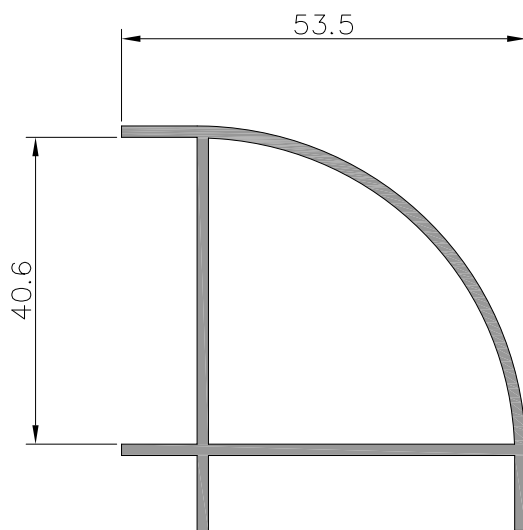

4132

Esquinero curvo de 40 mm 90°

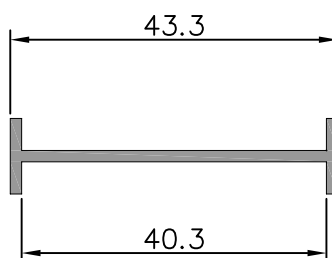

1213

H unión de 40 mm

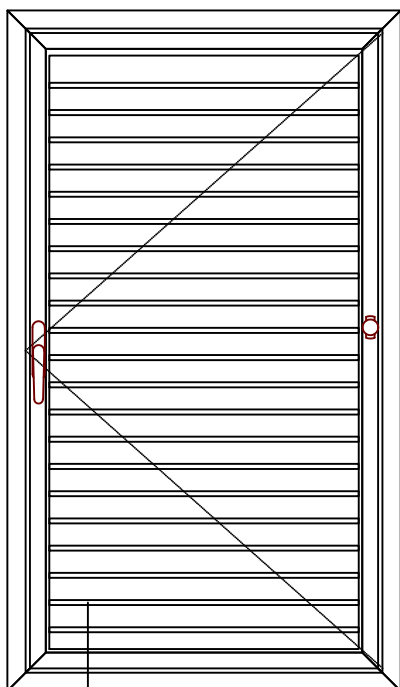

S1

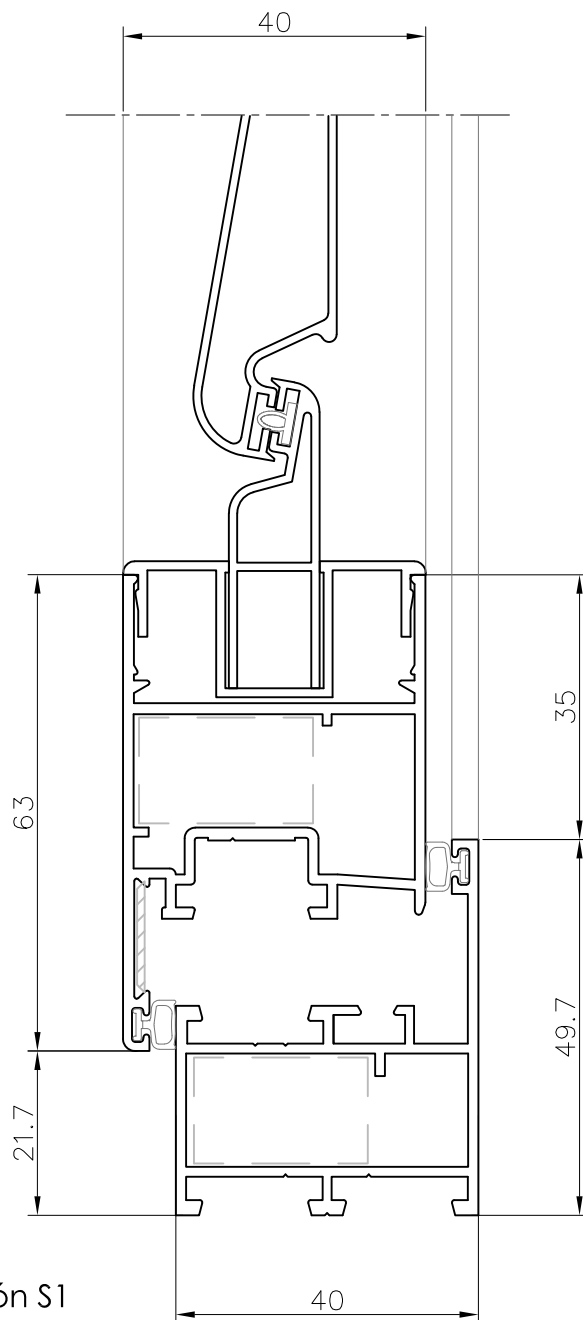

sección S1

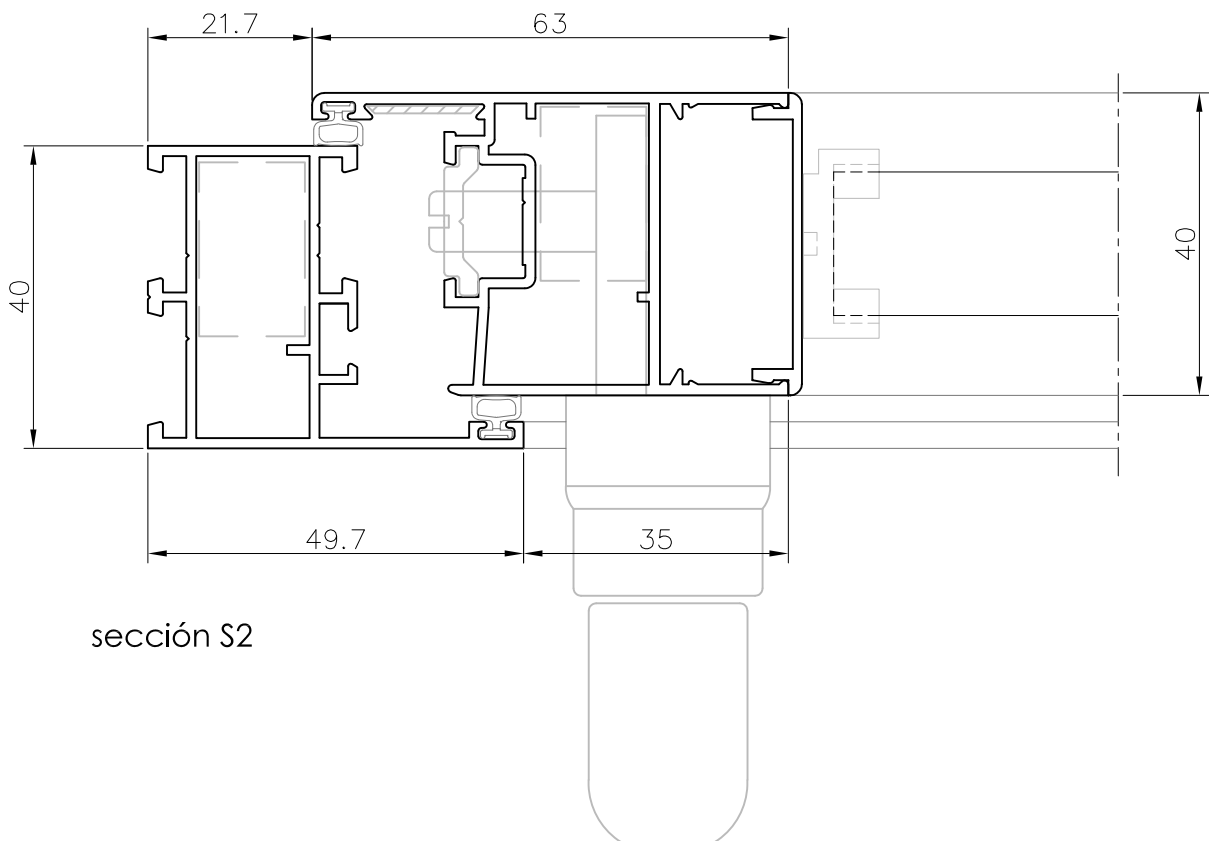
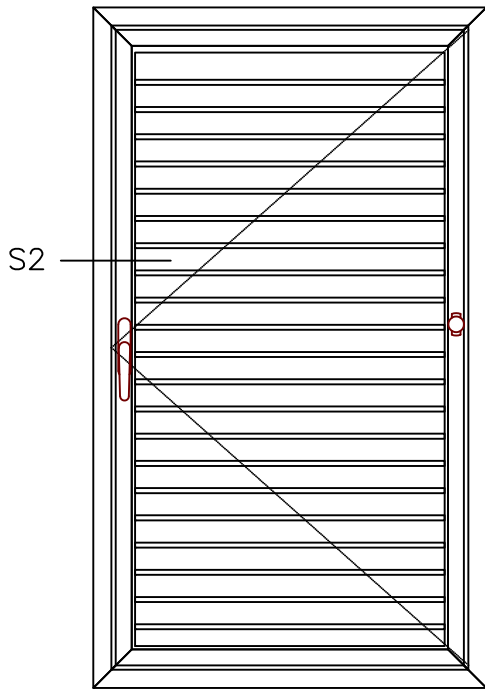

sección S2

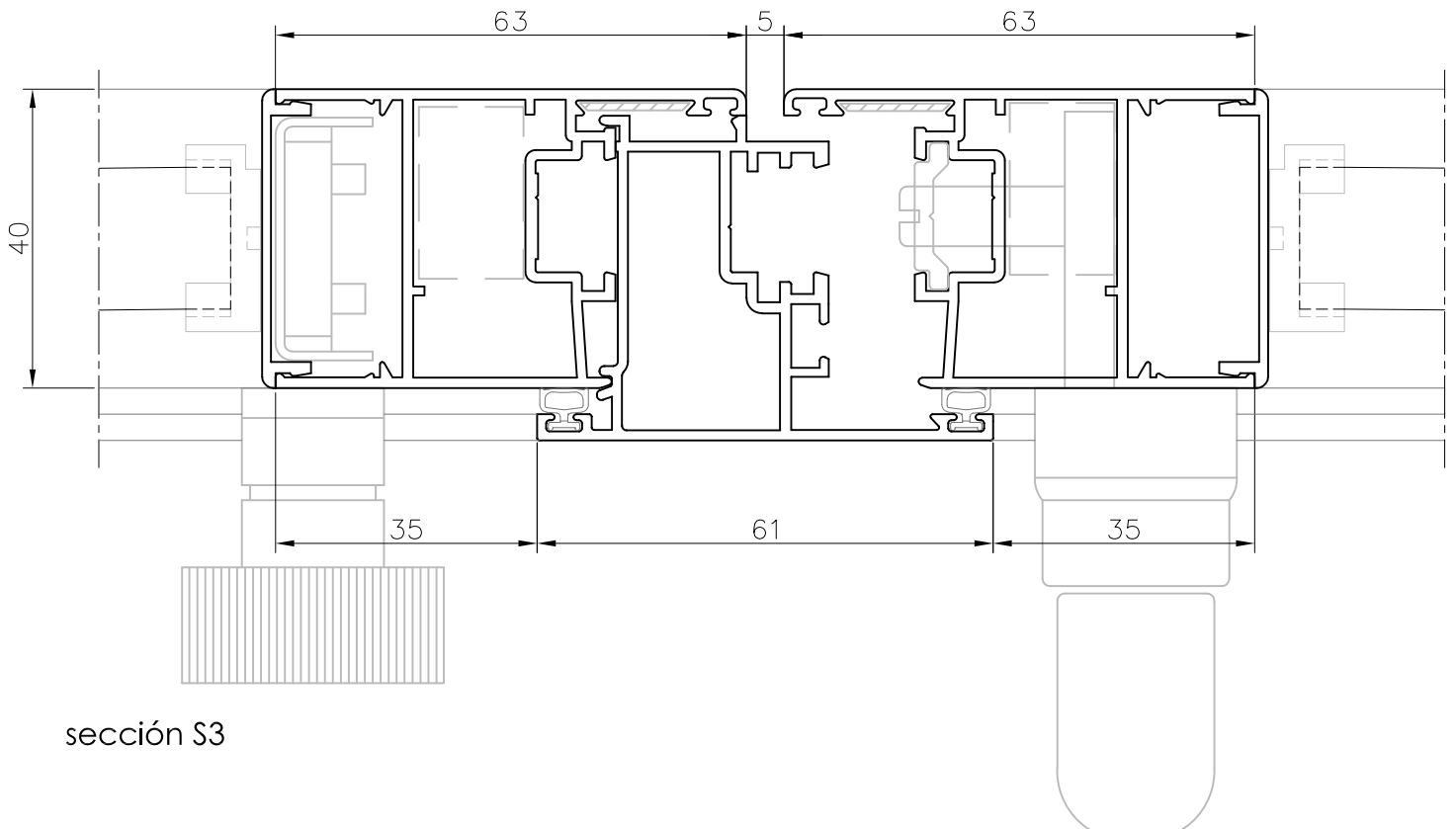
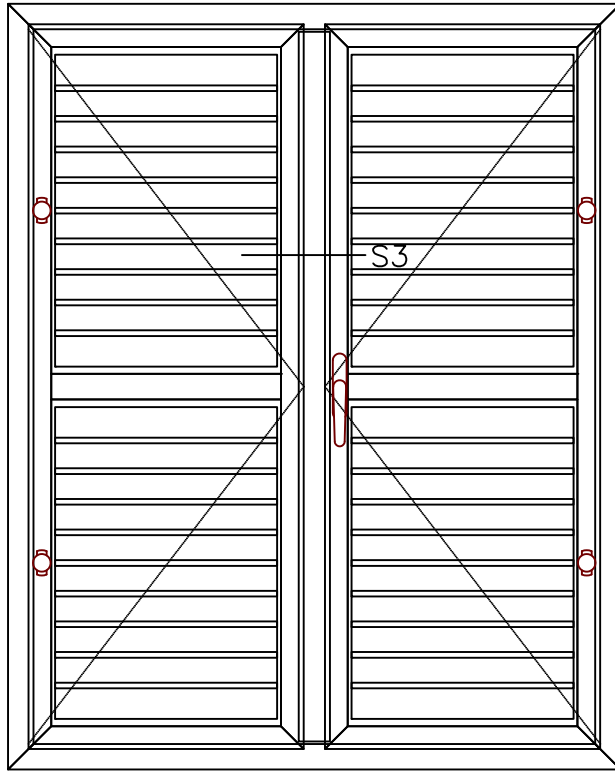

sección S3

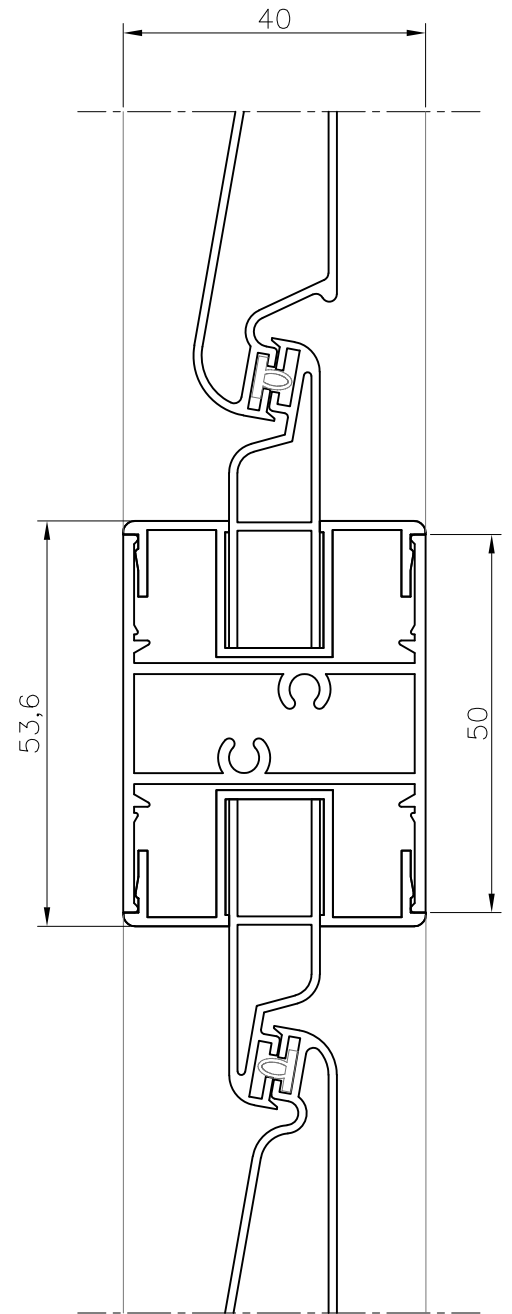
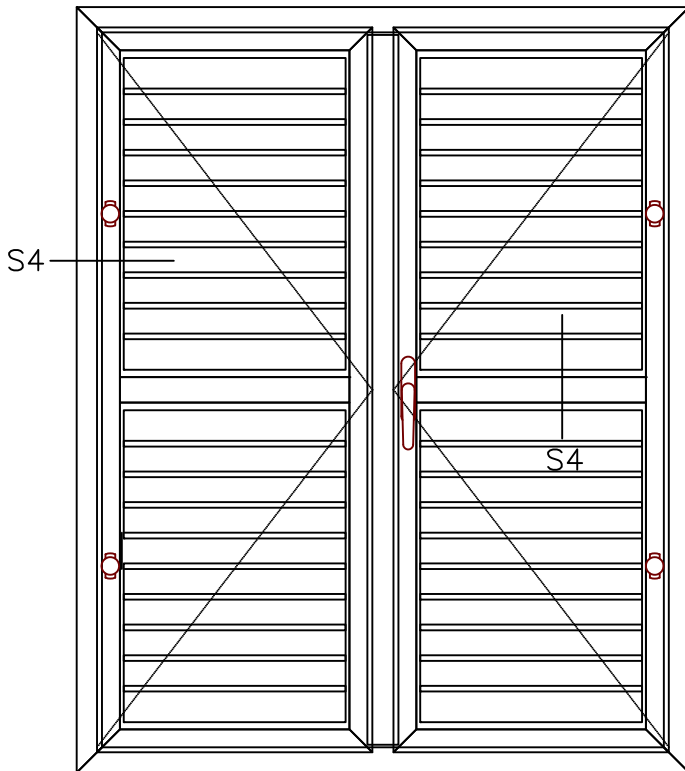

sección S4

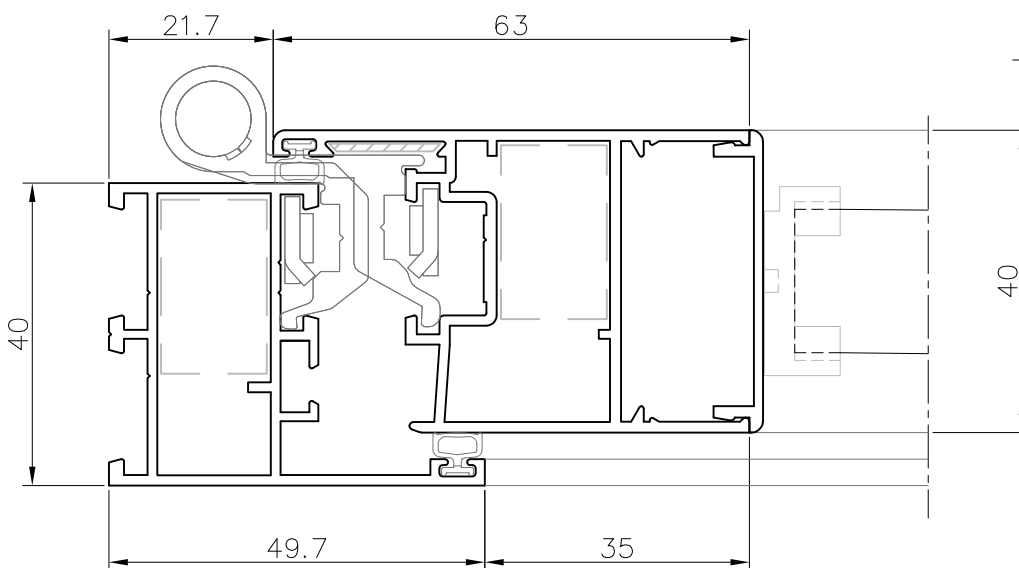

sección S4

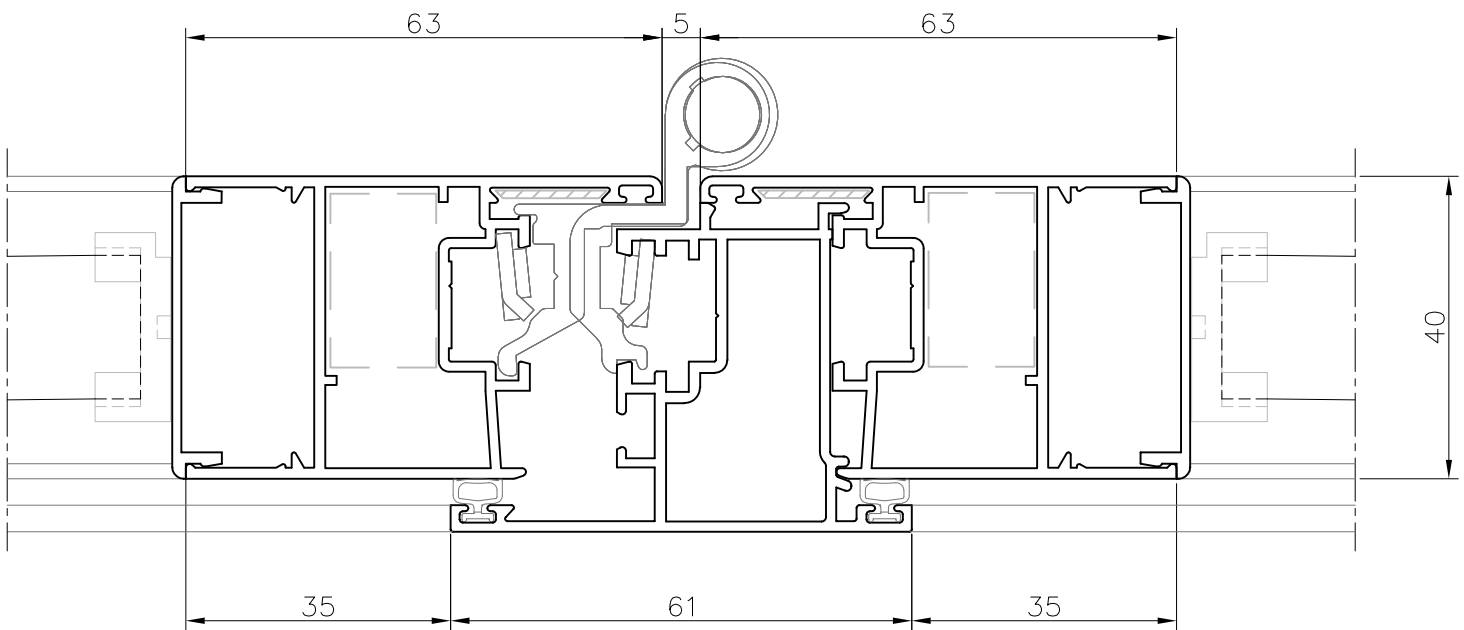
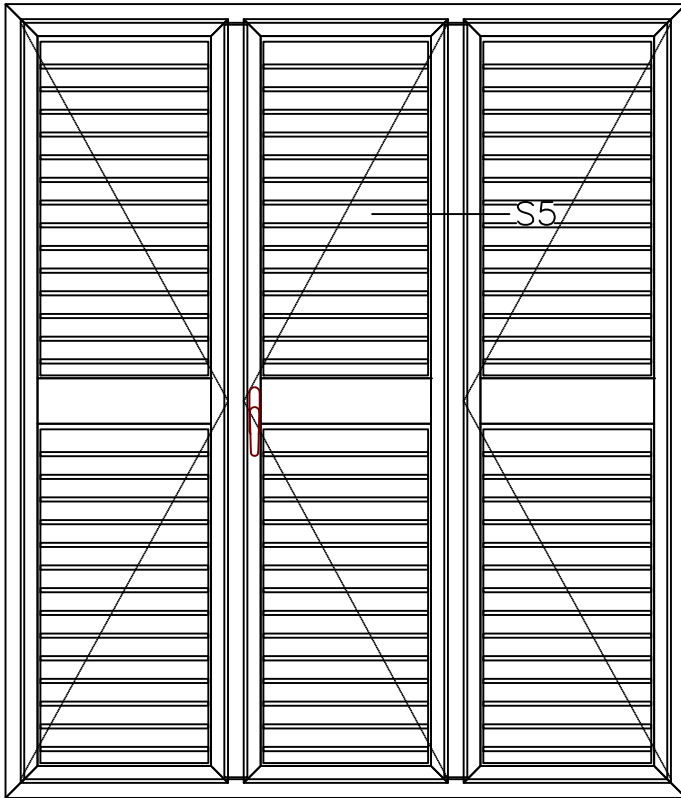

sección S5

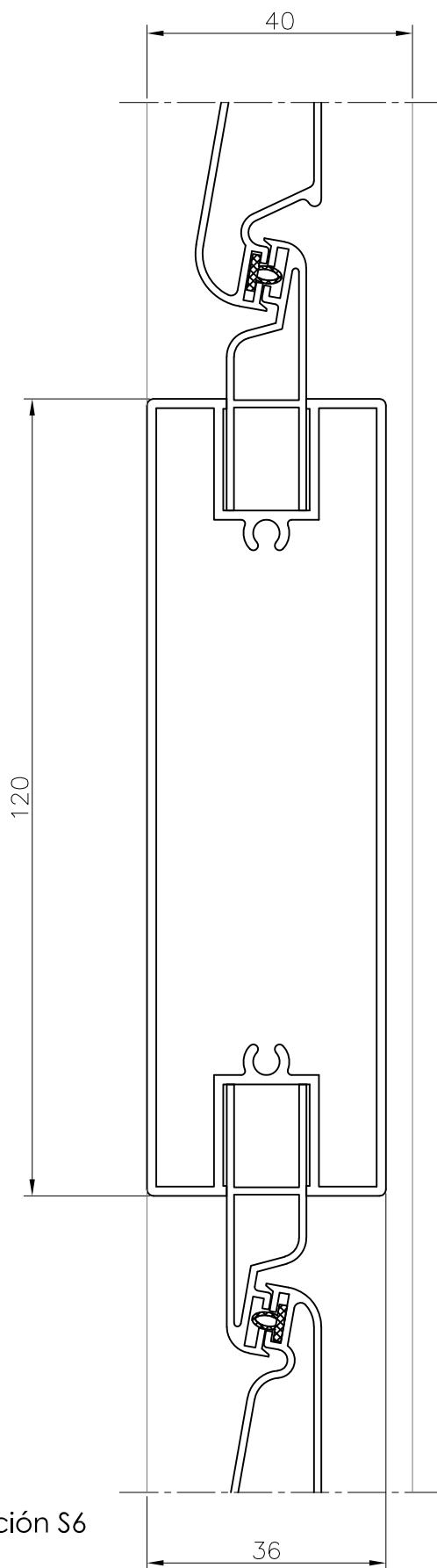
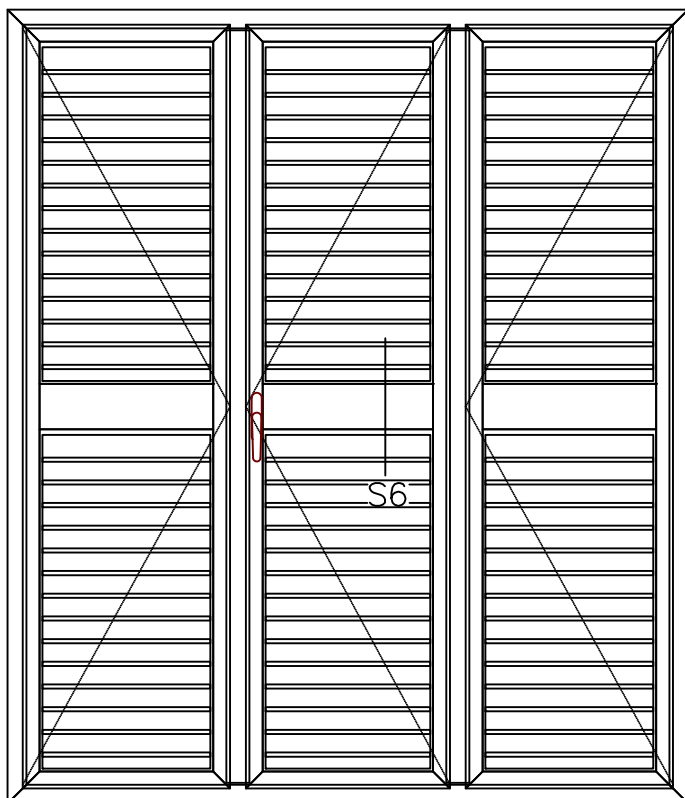

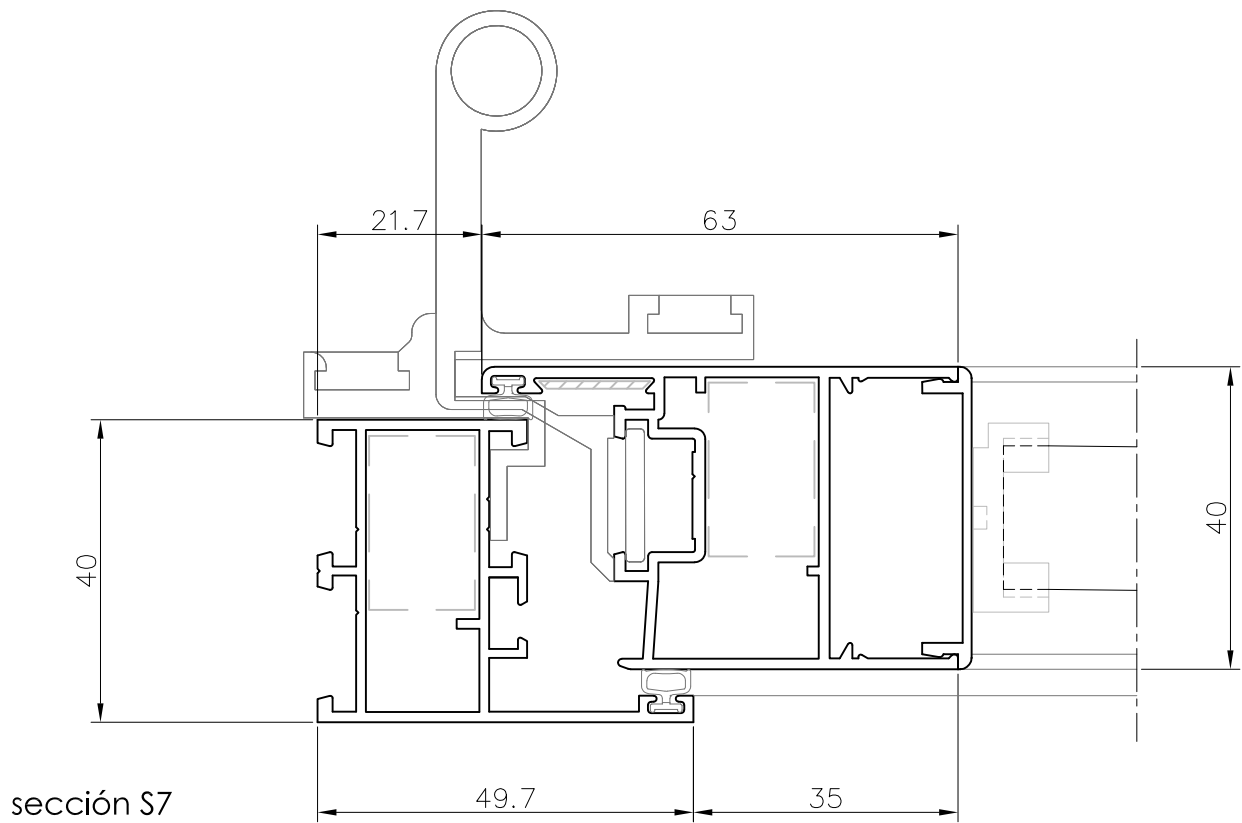
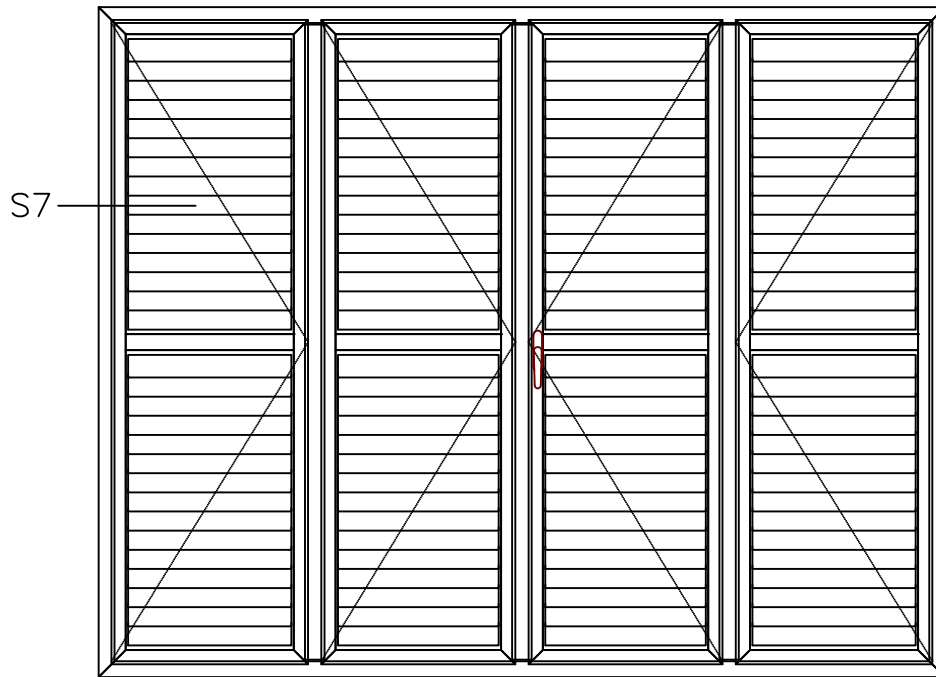

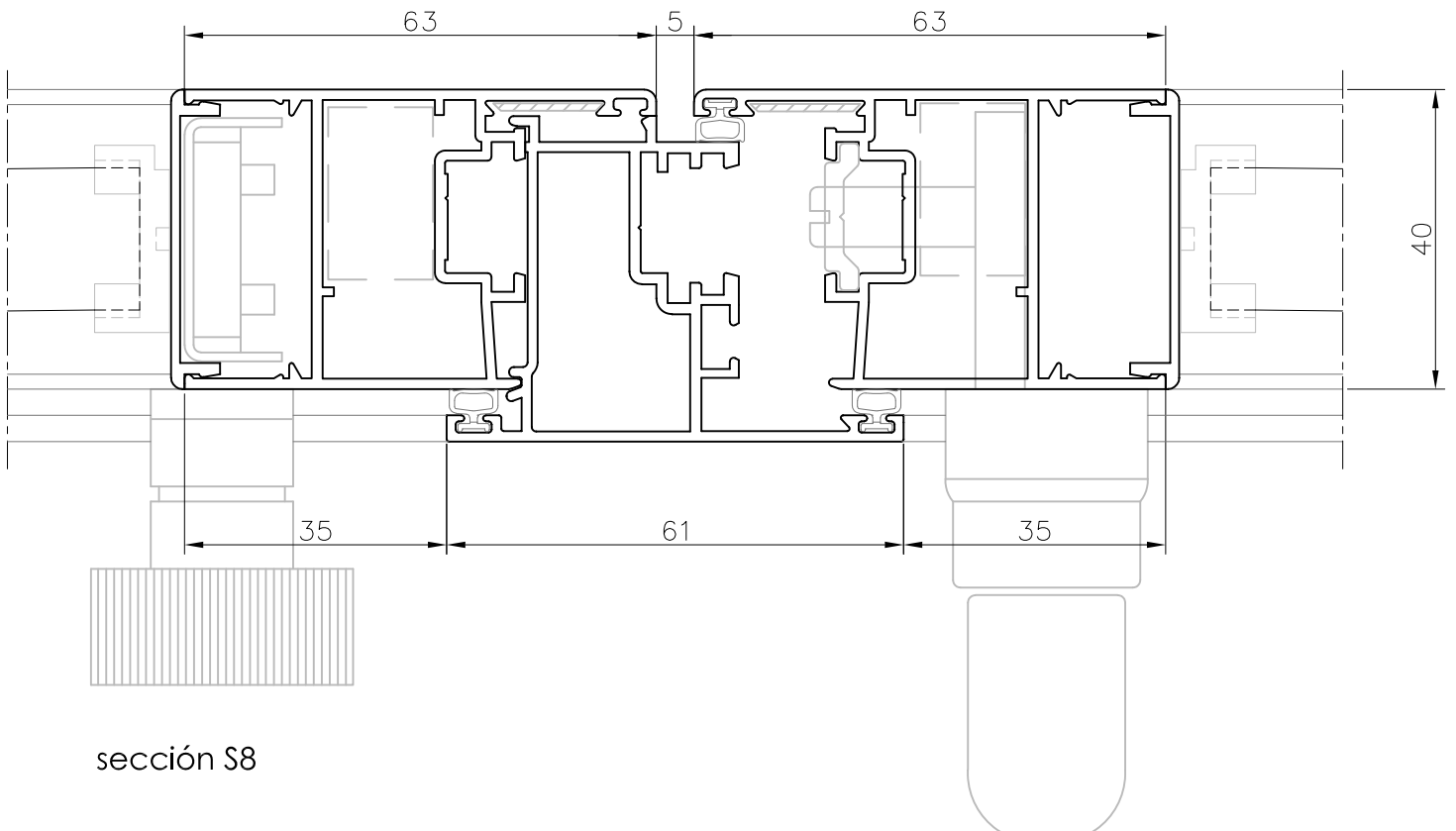
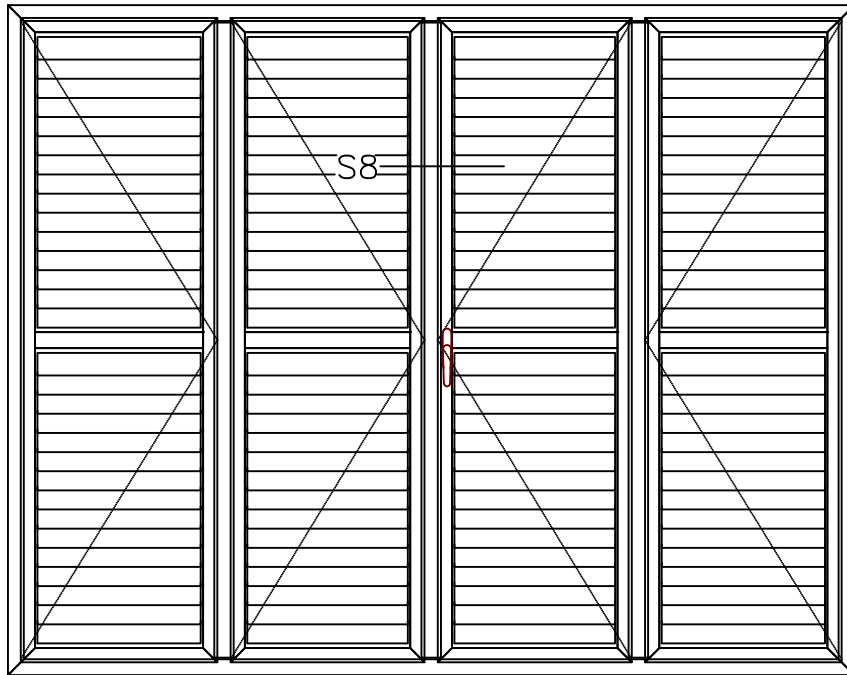

sección S8

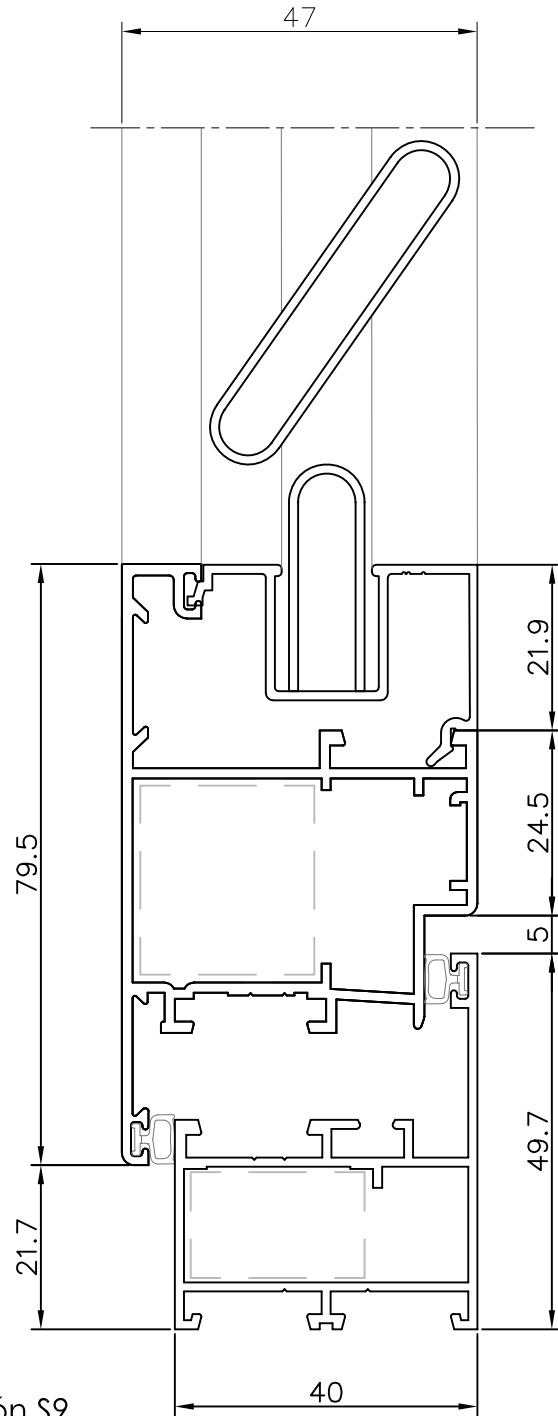
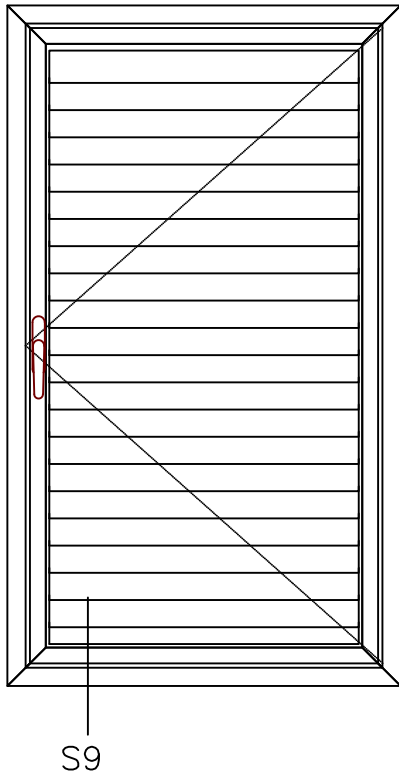

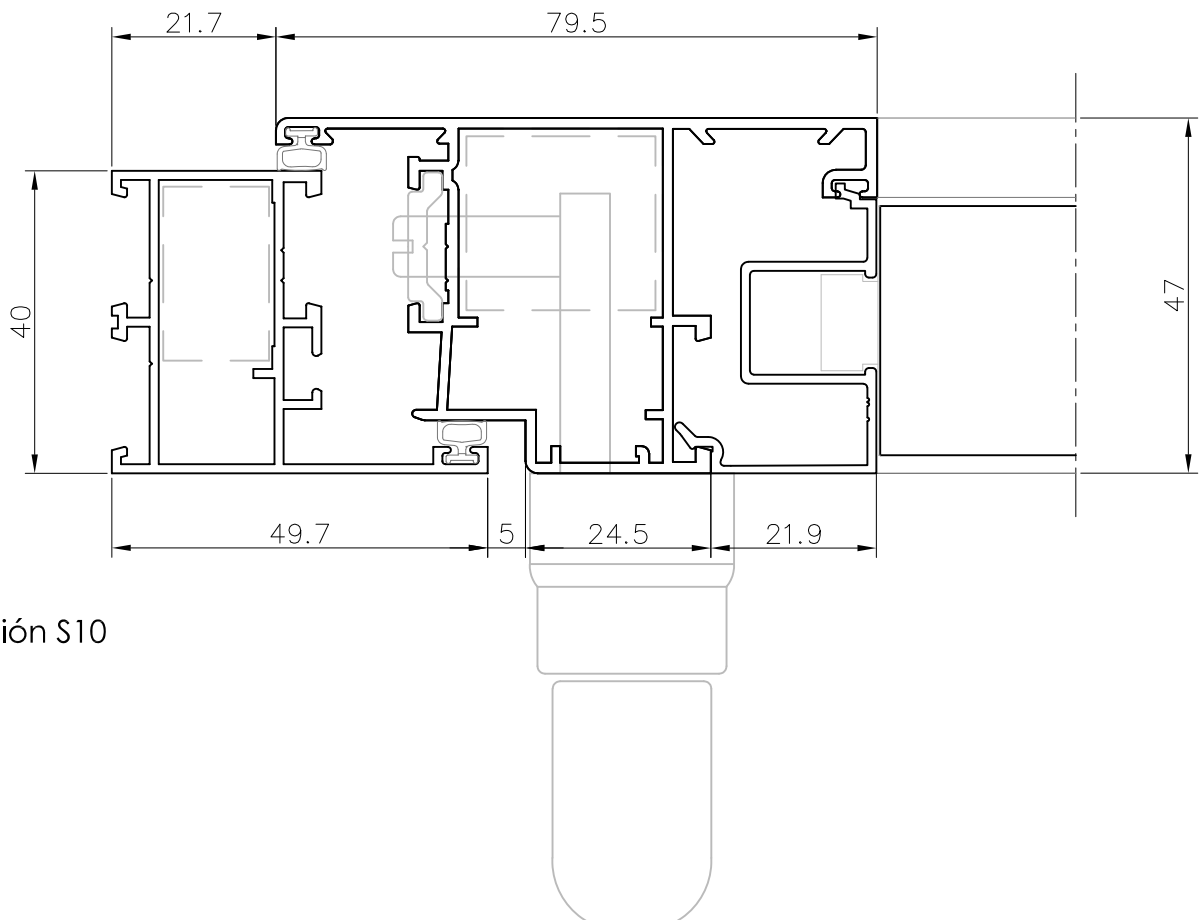
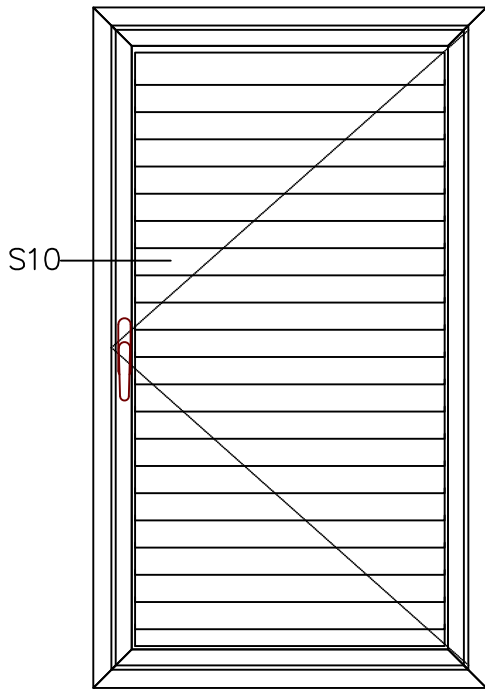

sección S10

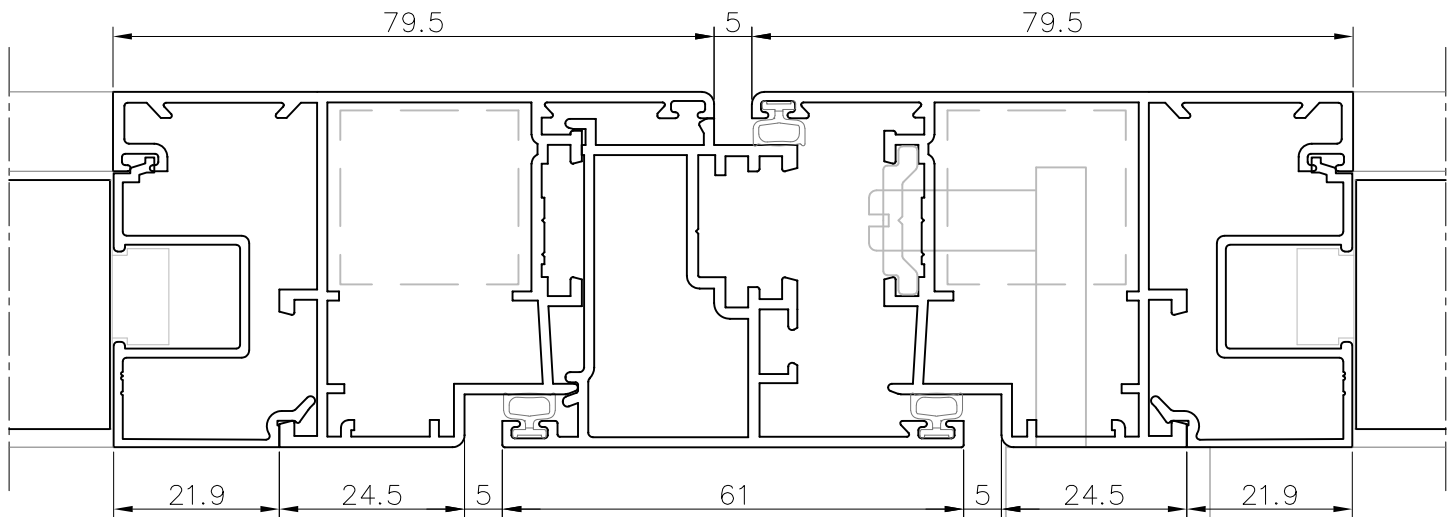
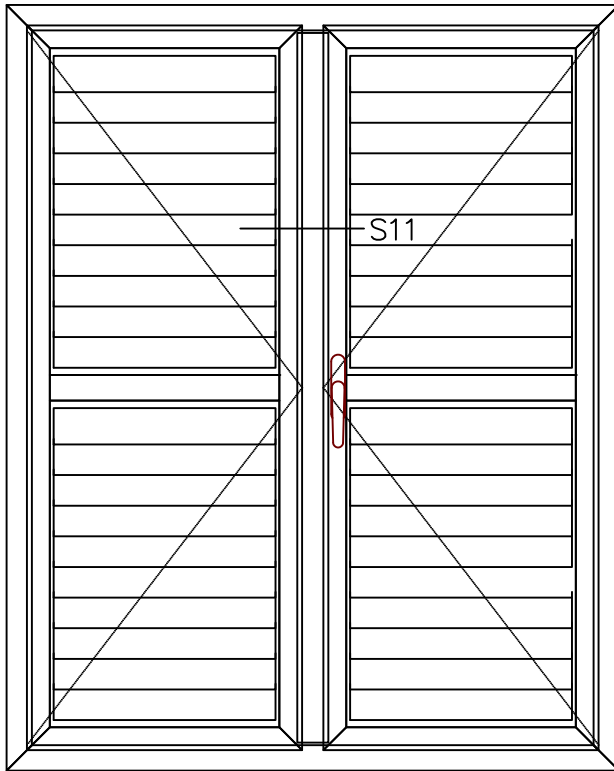

sección S11

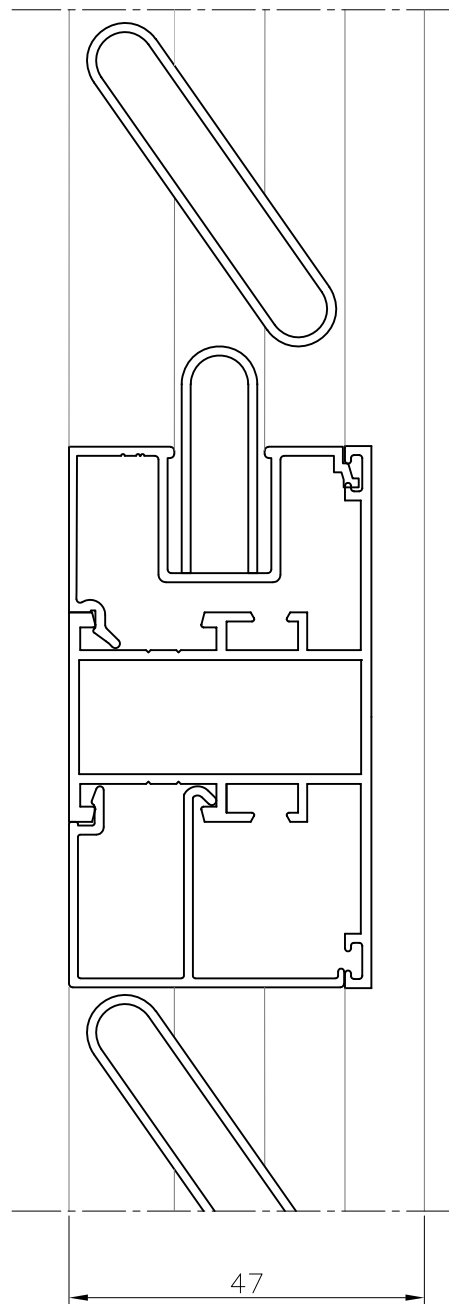
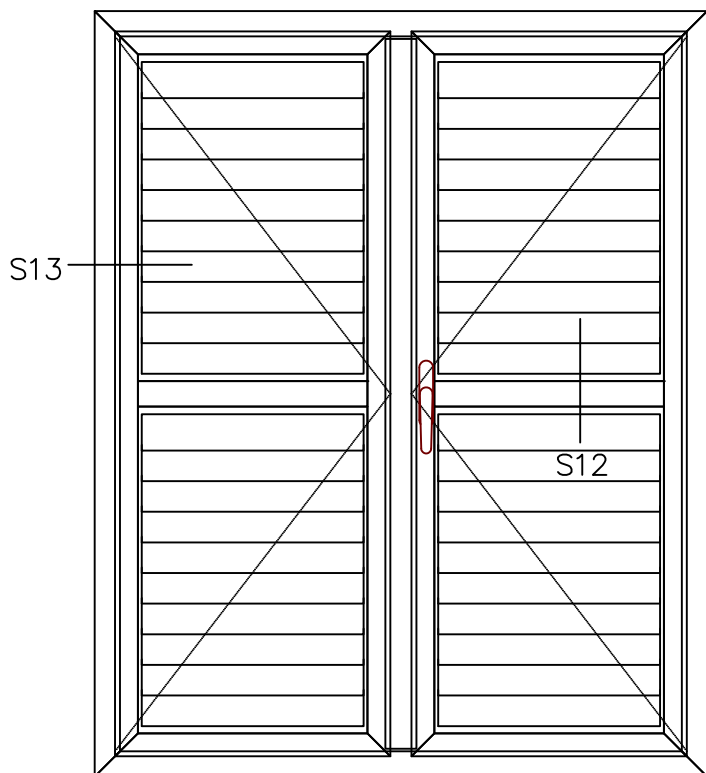

sección S12

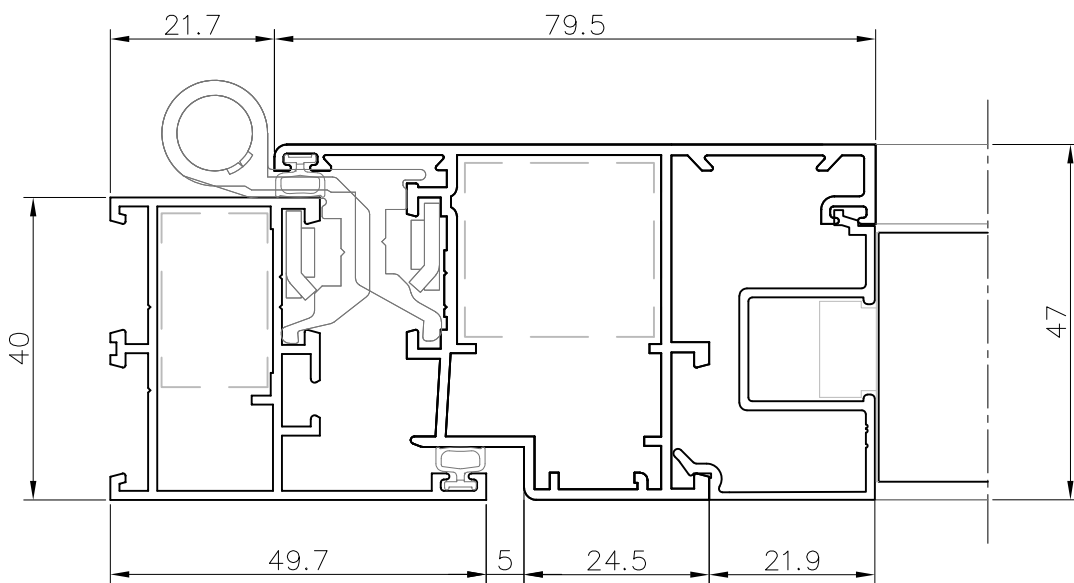

sección S13

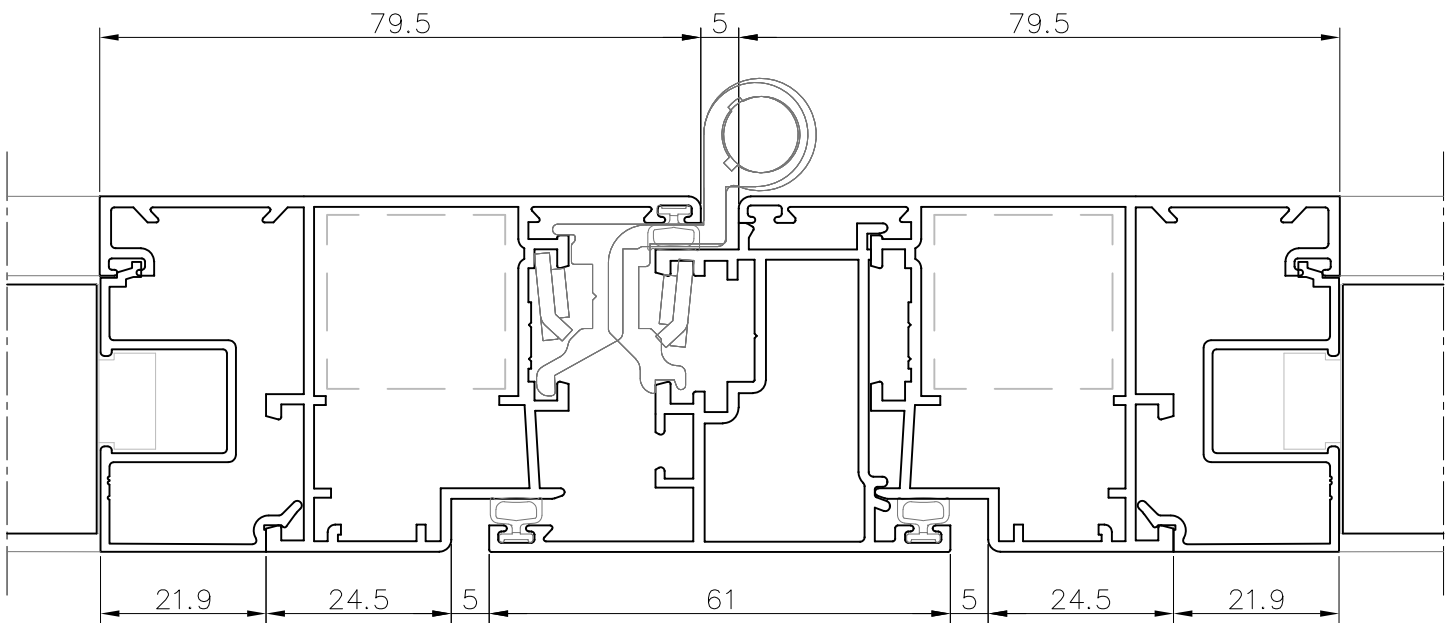
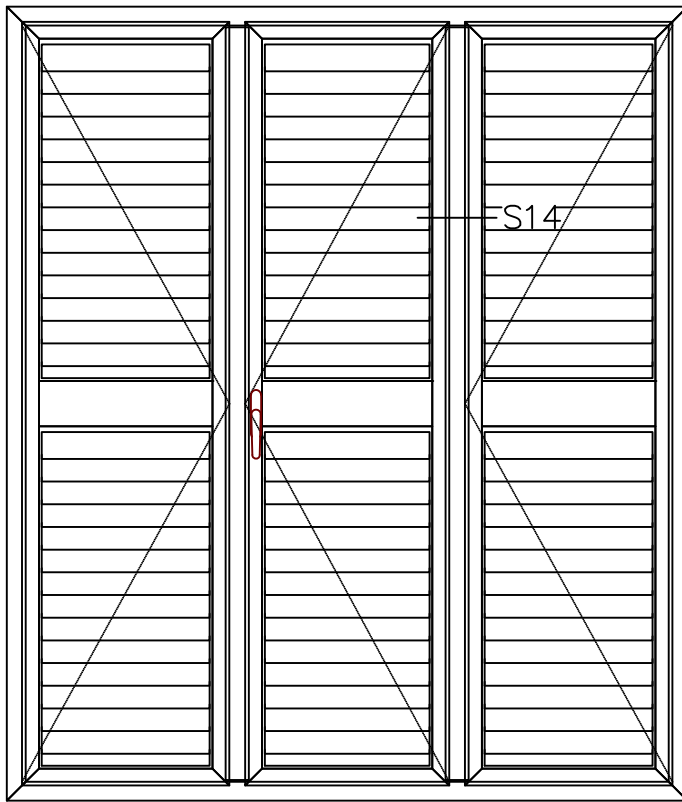

sección S14

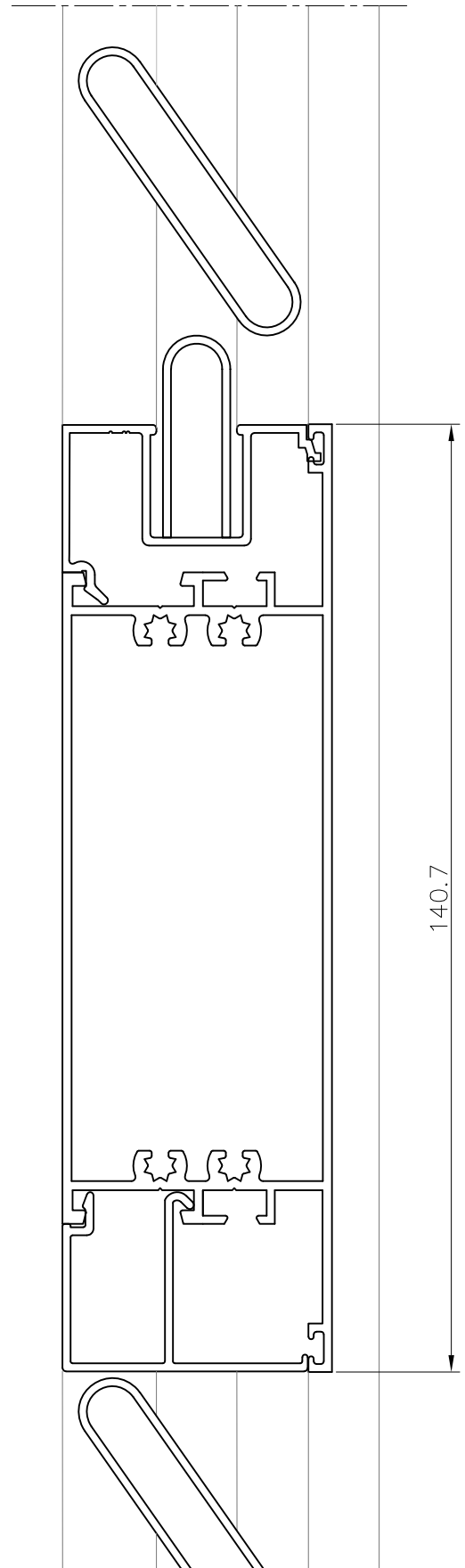
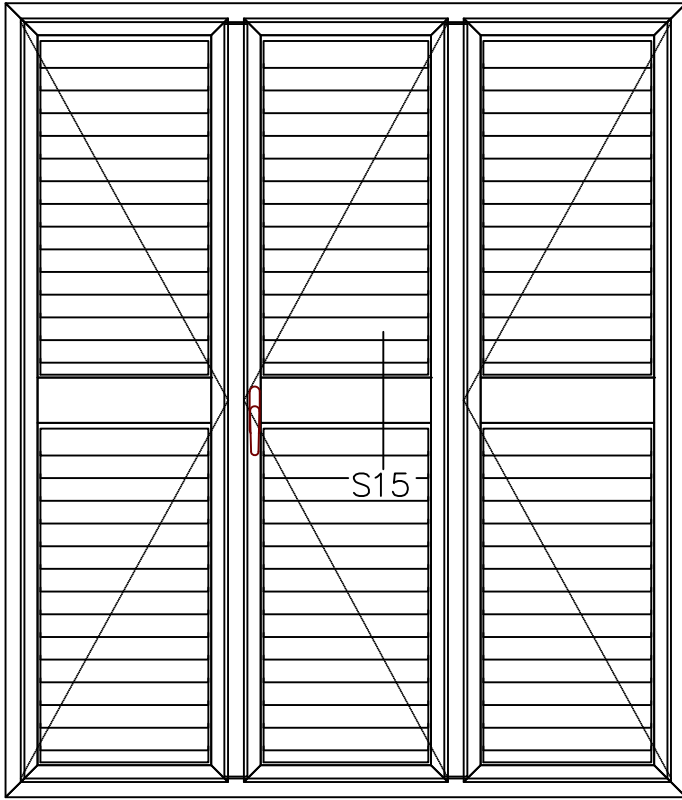

sección S15

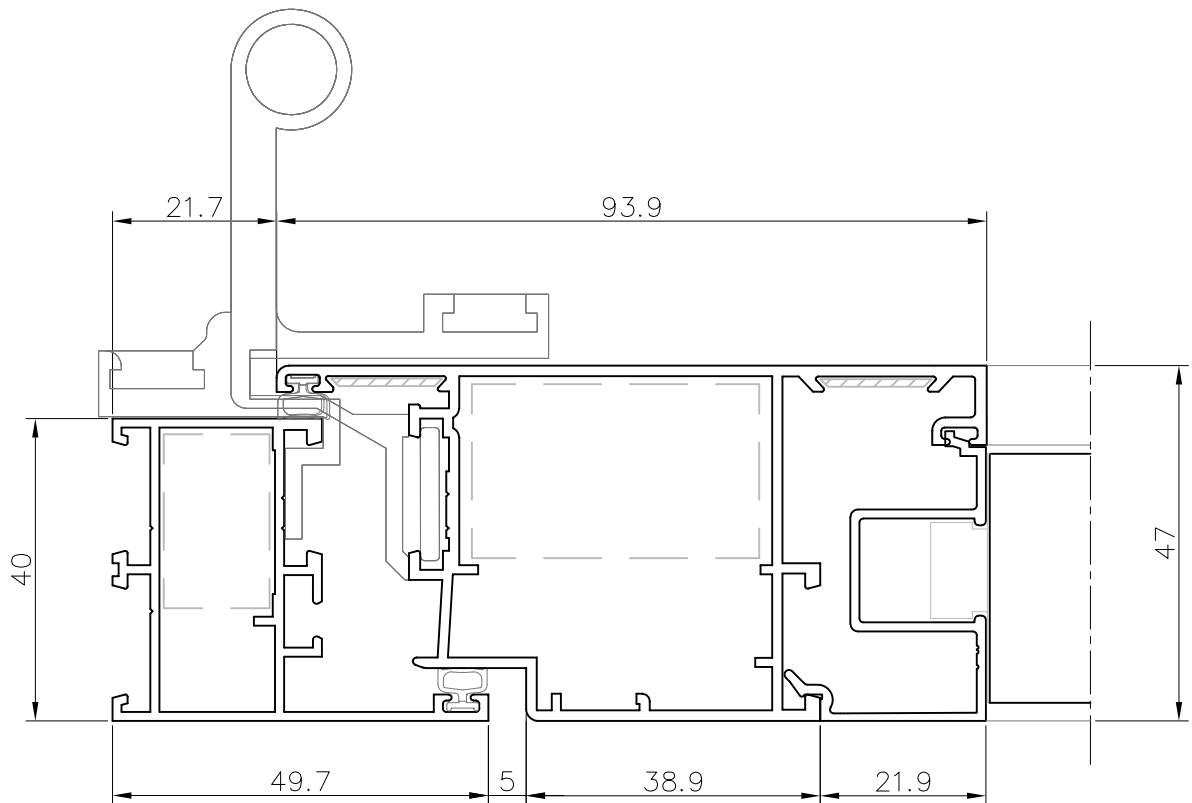
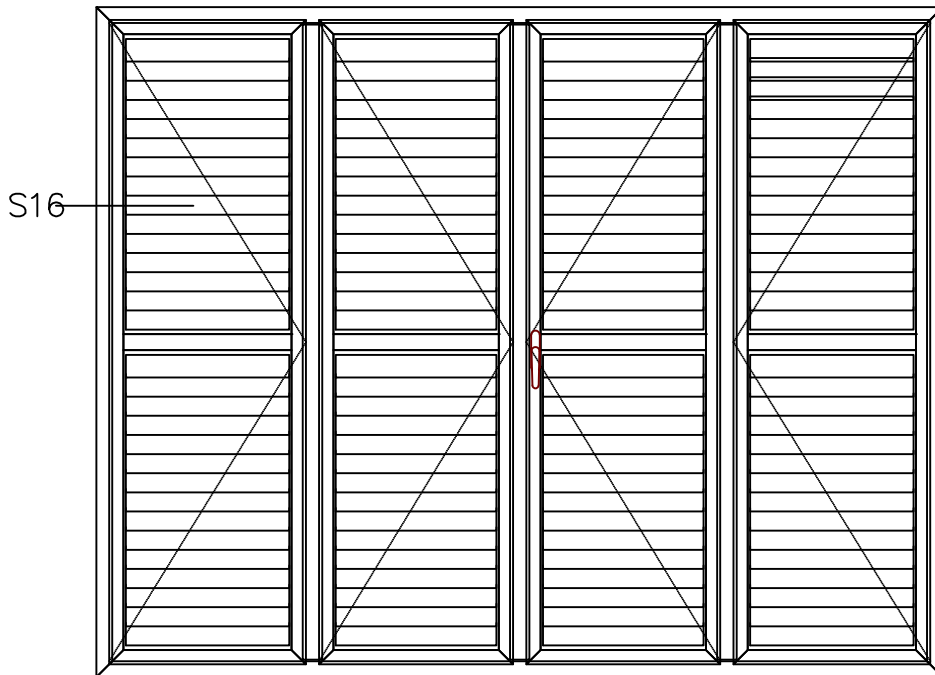

sección S16

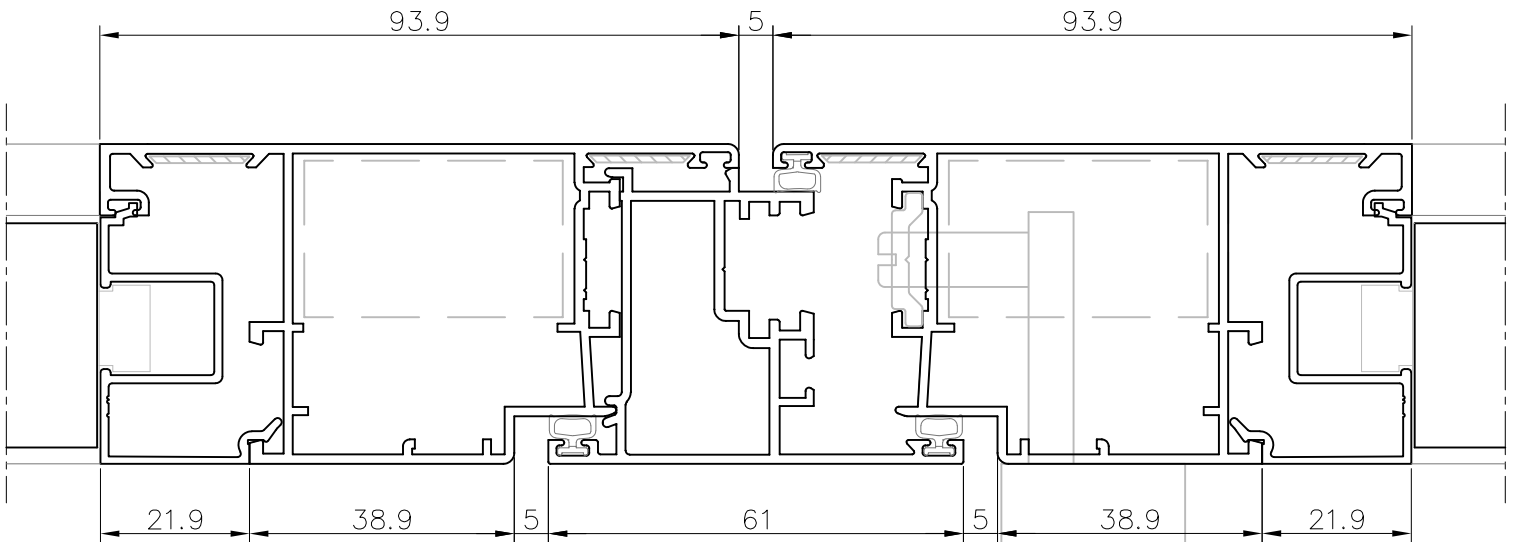
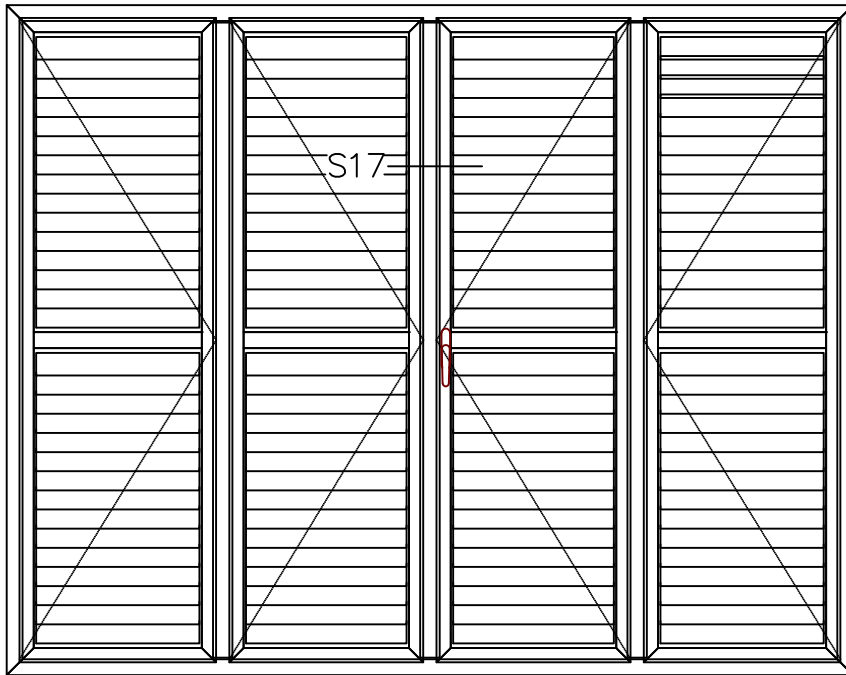

sección S17

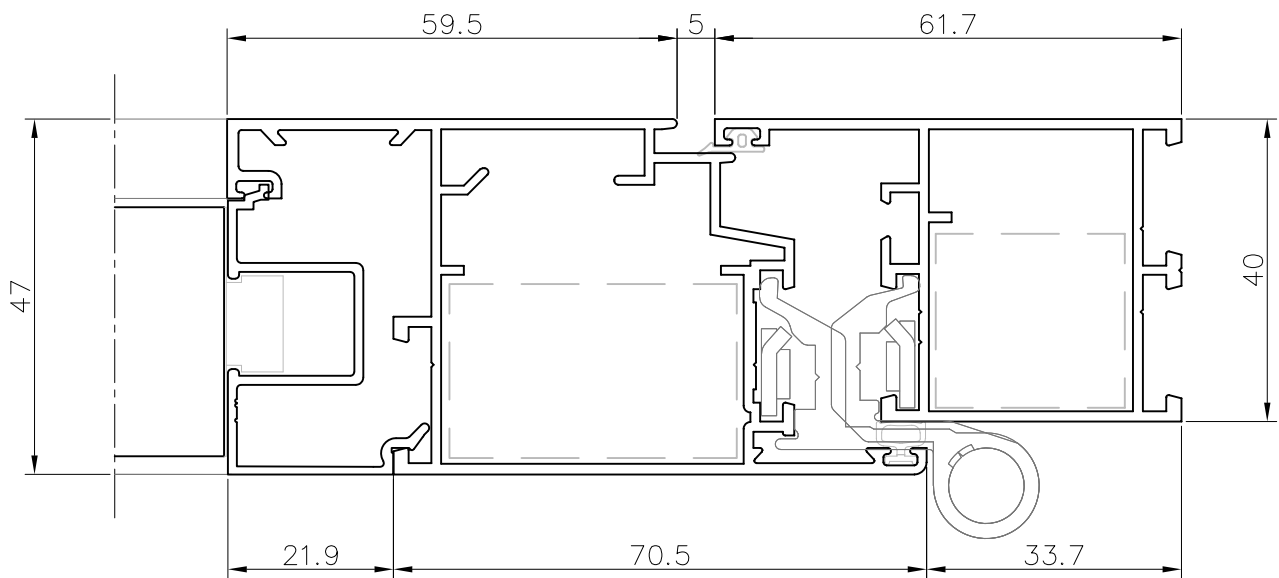
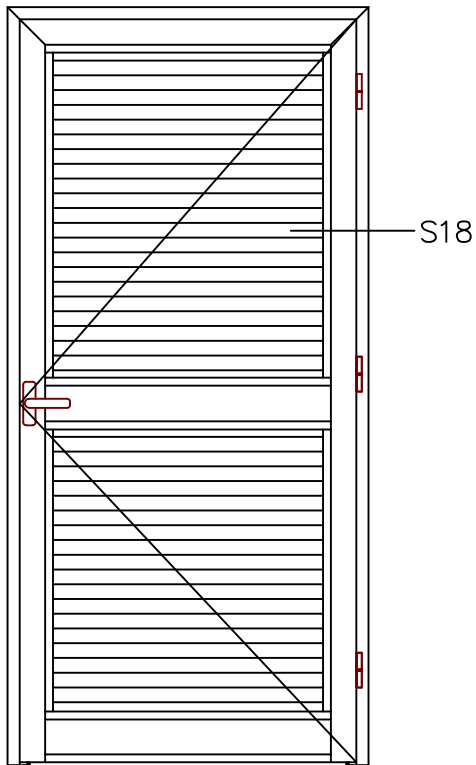

sección S18

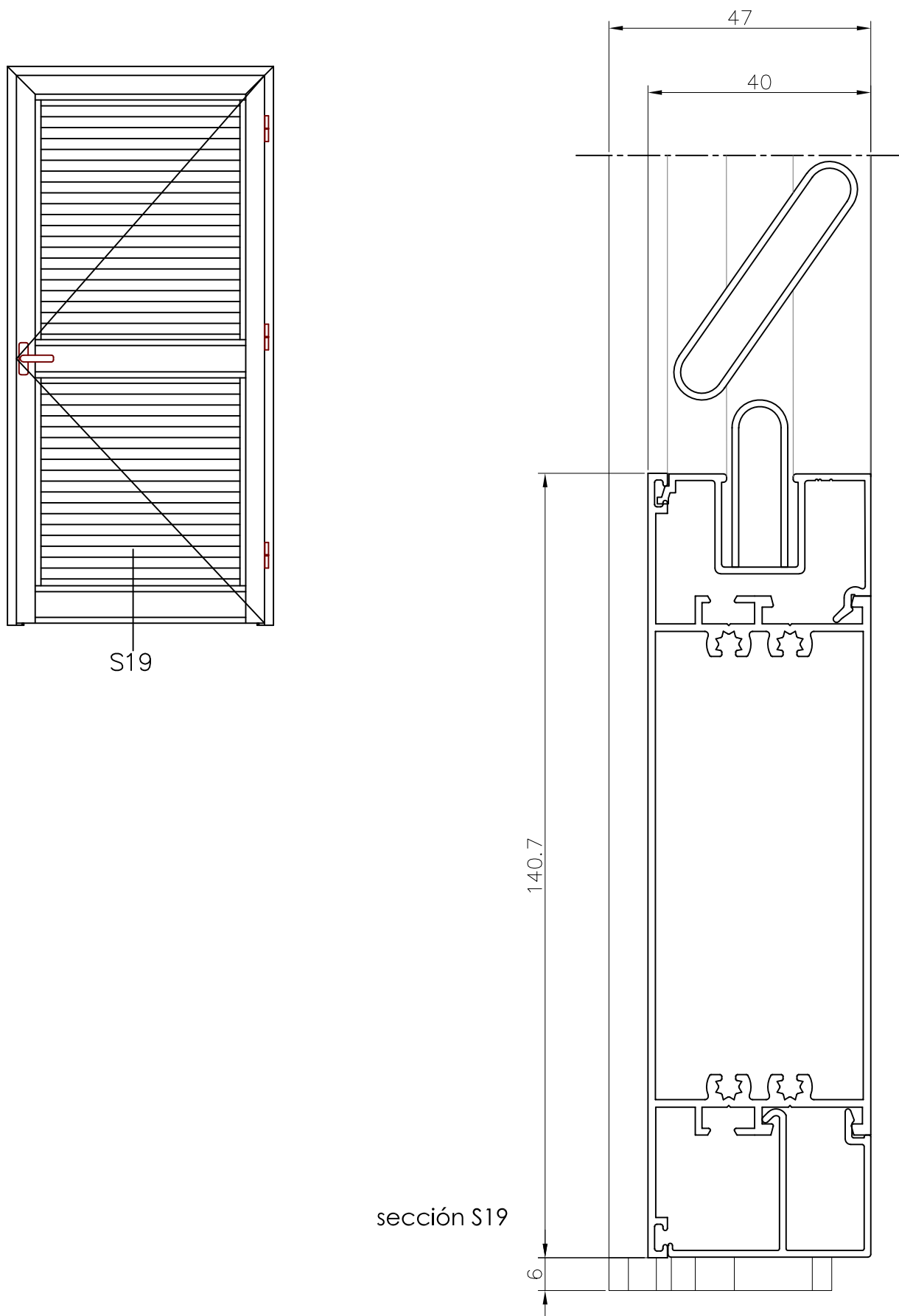

Ventana Mallorquina 1 Hoja
 - Lama Orientable-

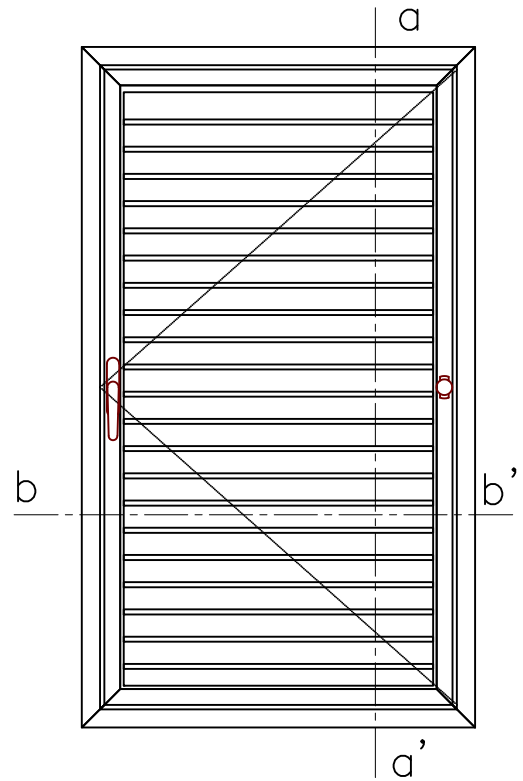
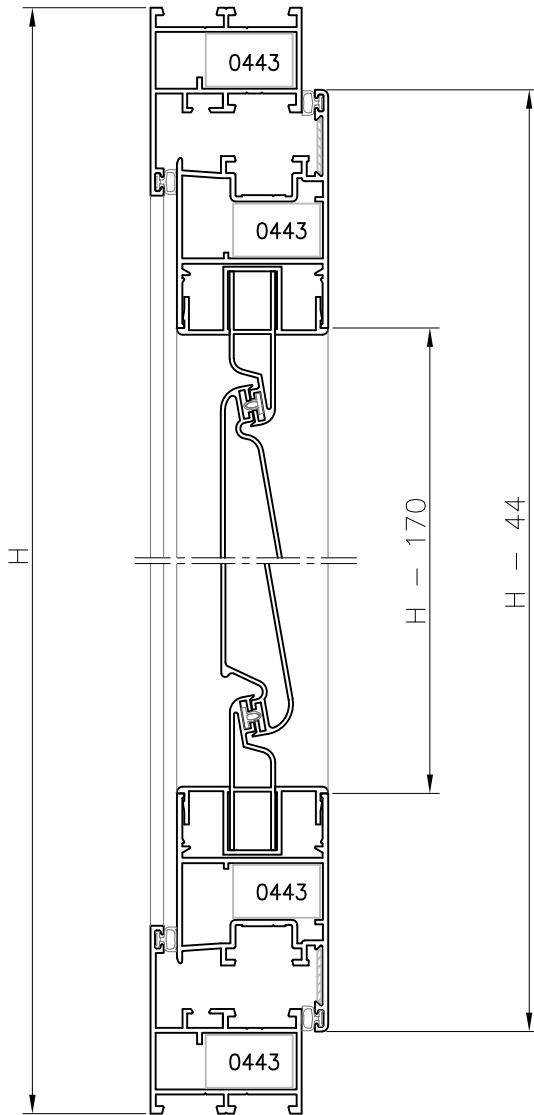



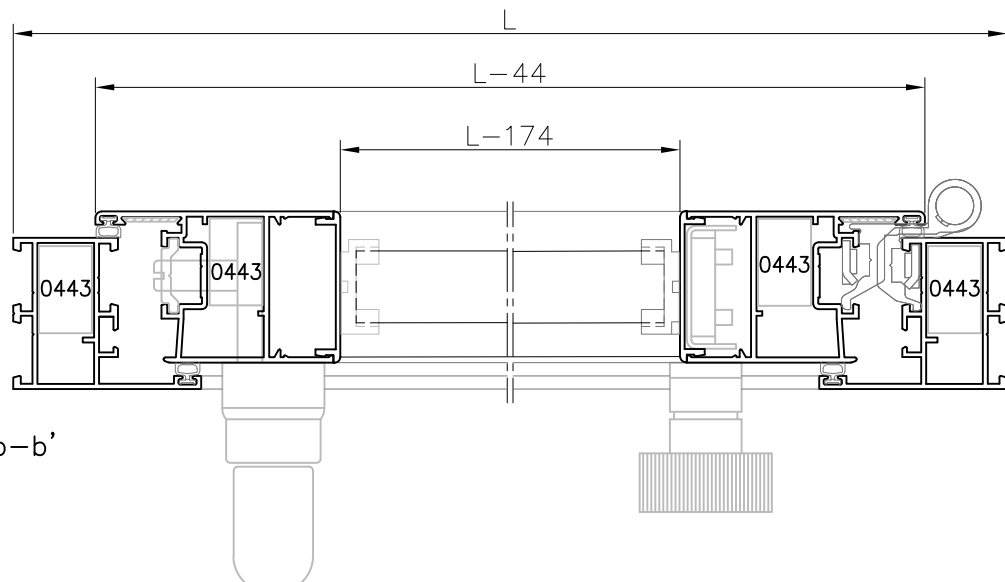





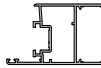

Sección a-a'
 e: 1/2



Sección b-b'
 e: 1/2

HOJA DE CORTE Y ACCESORIOS

perfiles					
SECCIÓN	DESCRIPCIÓN	REFERENCIA	CORTE	MEDIDA	CANTIDAD
	cerco 15 mm	4101		L	2
				H	2
	hoja recta 15 mm	4201		L - 44	2
				H - 44	2
	perfil base en U	4221		L - 174	2
	lama compensación de 57 mm	4222		L - 182	2
	lama orientable	4224		L - 182	según altura

accesorios		
DESCRIPCIÓN	REFERENCIA	CANTIDAD
escuadra cerco/hoja	0443	8
escuadra alineamiento hoja	1200	4
mecanismo para lama móvil	ver tabla mecanismos	1
mando ROTARY negro ambas manos	9750	1

juntas		
DESCRIPCIÓN	REFERENCIA	CANTIDAD
junta estanqueidad burbuja	309.043.TP	2 L 2 H
junta lama orientable	331.050.C1	según nº lamas

Ventana Mallorquina 2 Hojas
 - Lama Orientable-

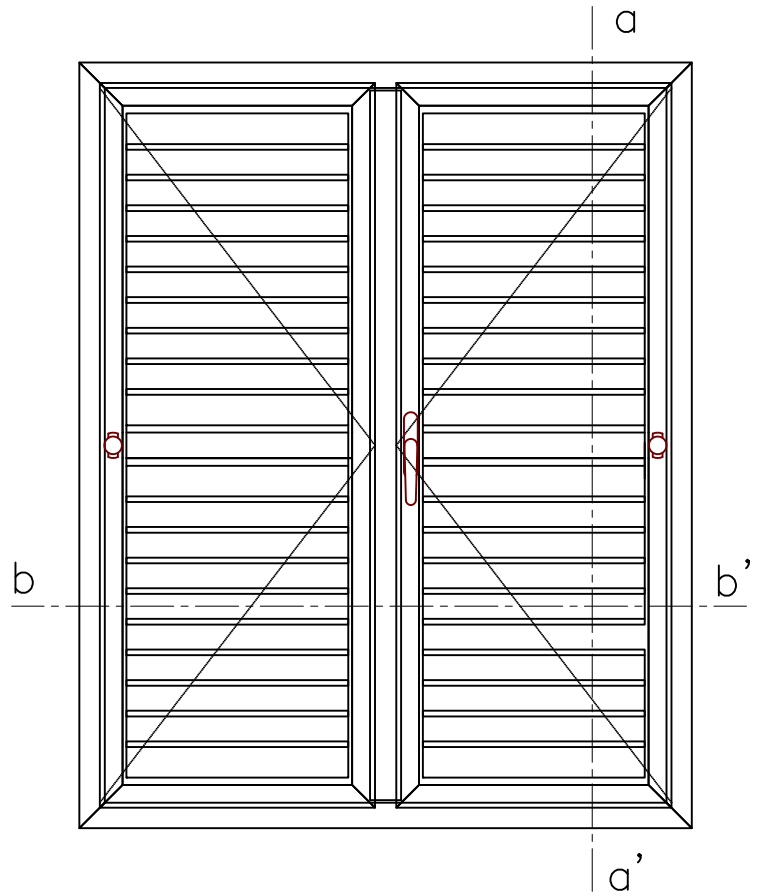
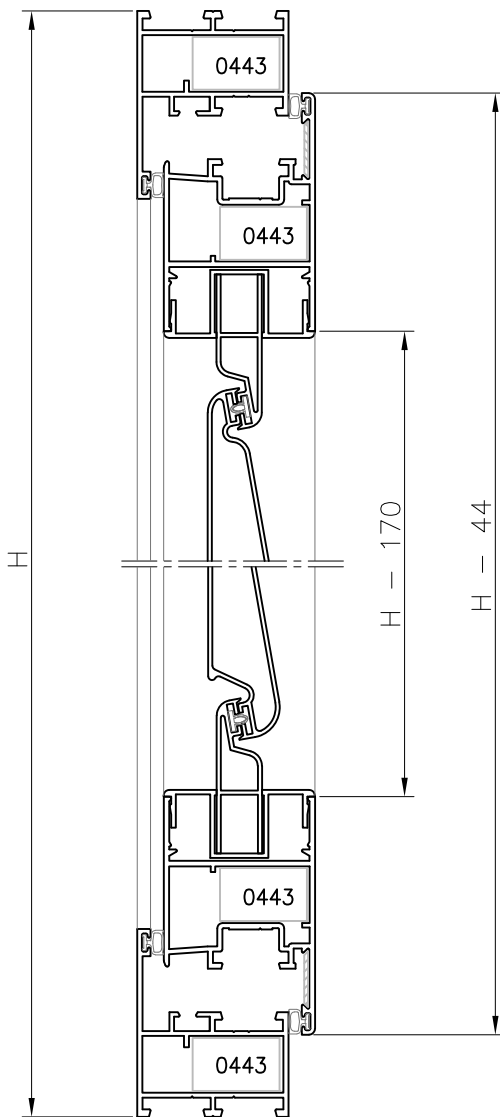



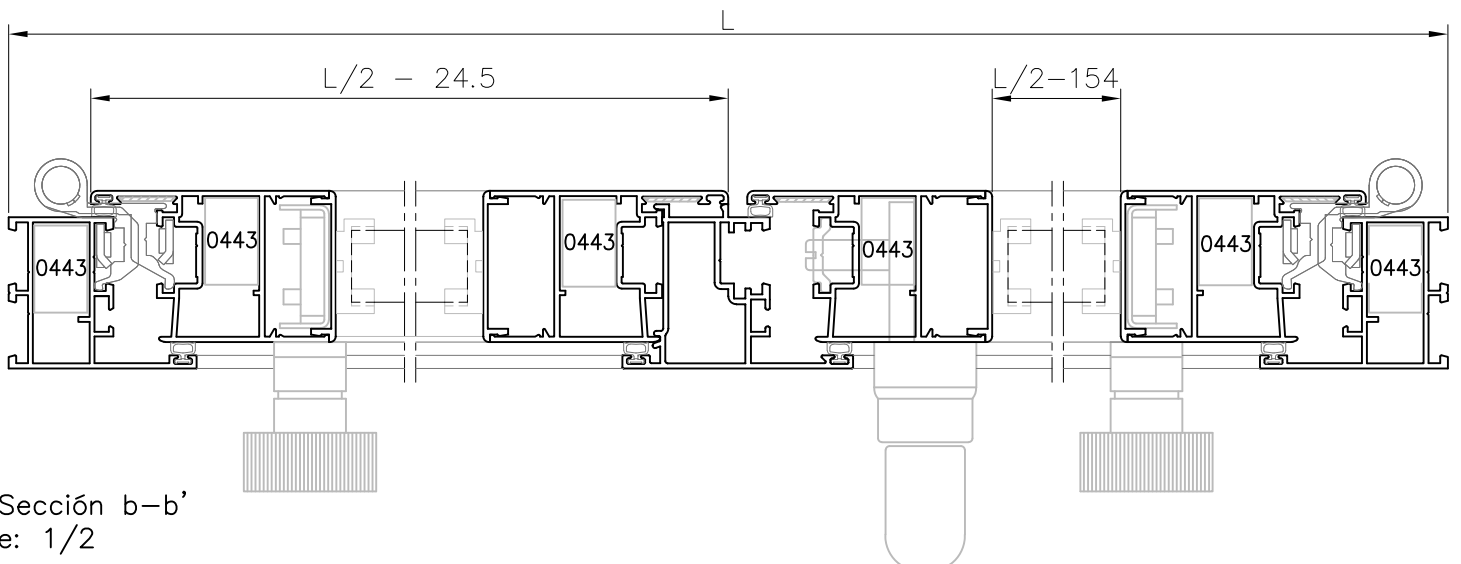











Sección a-a'
 e: 1/2



Sección b-b'
 e: 1/2

HOJA DE CORTE Y ACCESORIOS

perfiles					
SECCIÓN	DESCRIPCIÓN	REFERENCIA	CORTE	MEDIDA	CANTIDAD
	cerco 15 mm	4101		L	2
				H	2
	hoja recta 15 mm	4201		L/2 - 24.5	4
				H - 44	4
	inversor	4231		H - 110	1
	perfil base en U	4221		L/2 - 154	4
	lama compensación de 57 mm	4222		L/2 - 163	4
	lama orientable	4224		L/2 - 163	según altura







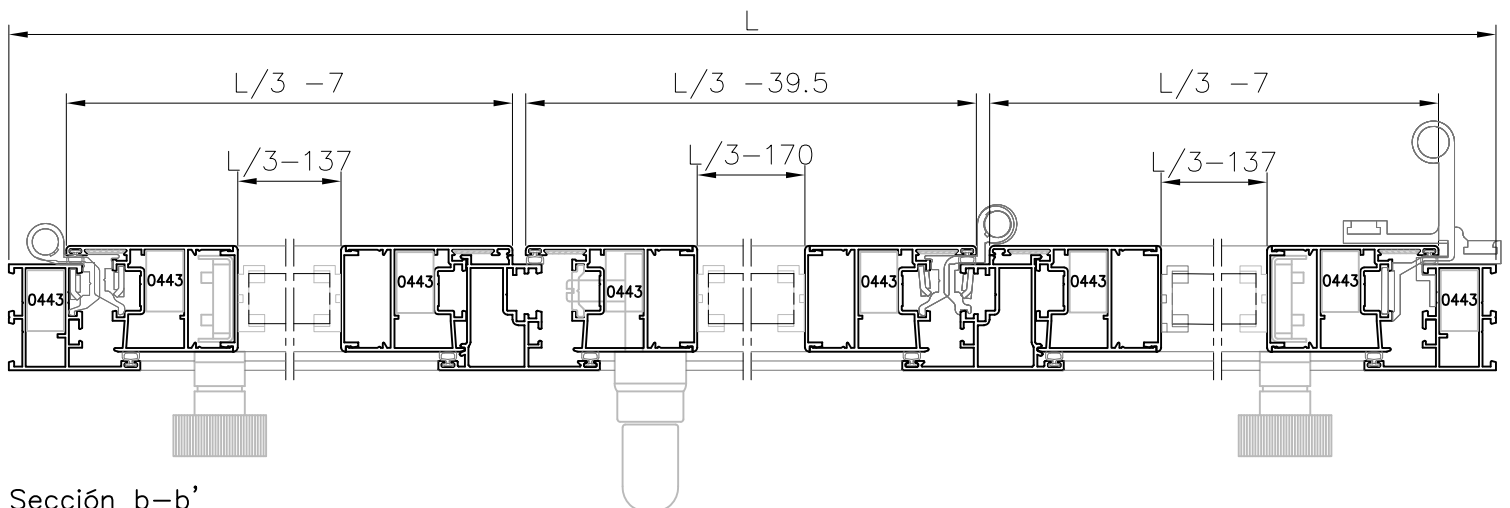
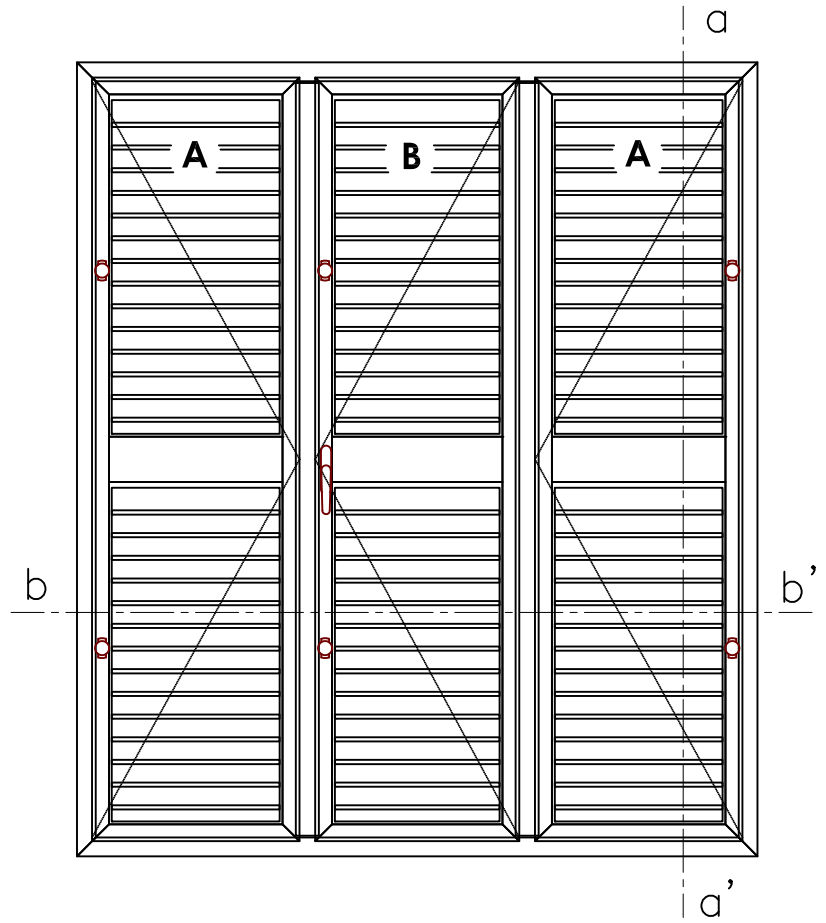
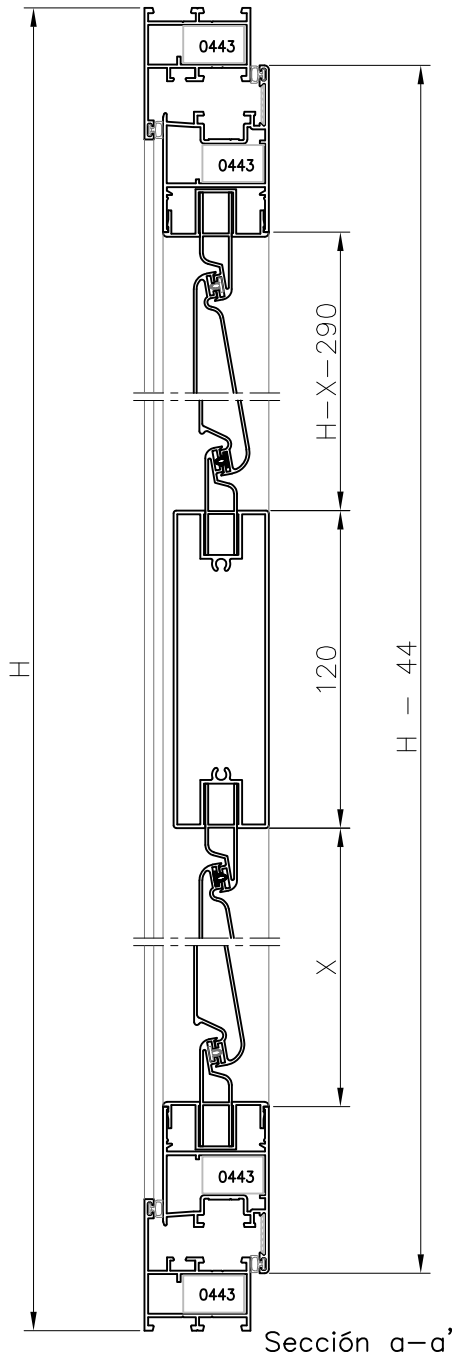





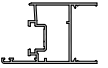







accesorios		
DESCRIPCIÓN	REFERENCIA	CANTIDAD
escuadra cerco/hoja	0443	12
escuadra alineamiento hoja	1200	8
tapa inversor 4231	INE1903	1
mecanismo para lama móvil	ver tabla mecanismos	2
mando ROTARY negro ambas manos	9750	2

juntas		
DESCRIPCIÓN	REFERENCIA	CANTIDAD
junta estanqueidad burbuja	309.043.TP	4 L 7 H
junta lama orientable	331.050.C1	según nº lamas

Balconera Mallorquina 3 Hojas
 - Lama Orientable-



HOJA DE CORTE Y ACCESORIOS

perfiles					
SECCIÓN	DESCRIPCIÓN	REFERENCIA	CORTE	MEDIDA	CANTIDAD
	cerco 15 mm	4101		L	2
				H	2
	hoja recta 15 mm	4201		A L/3 - 7	2
				B L/3 - 39.5	4
				H - 44	6
	inversor	4231		H - 110	2
	travesaño de 120 mm	4213		A L/3 - 99	2
				B L/3 - 132	1
	perfil base en U	4221		A L/3 - 137	8
				B L/3 - 170	4
	lama compensación de 57 mm	4222		A L/3 - 145	8
				B L/3 - 178	4
	lama orientable	4224		A L/3 - 145	según altura
				B L/3 - 178	

accesorios		
DESCRIPCIÓN	REFERENCIA	CANTIDAD
escuadra cerco/hoja	0443	16
escuadra alineamiento hoja	1200	12
tapa inversor 4231	INE1903	2
mecanismo para lama móvil	ver tabla mecanismos	6
mando ROTARY negro ambas manos	9750	6

juntas		
DESCRIPCIÓN	REFERENCIA	CANTIDAD
junta estanqueidad burbuja	309.043.TP	2 L 10 H
junta lama orientable	331.050.C1	según nº lamas

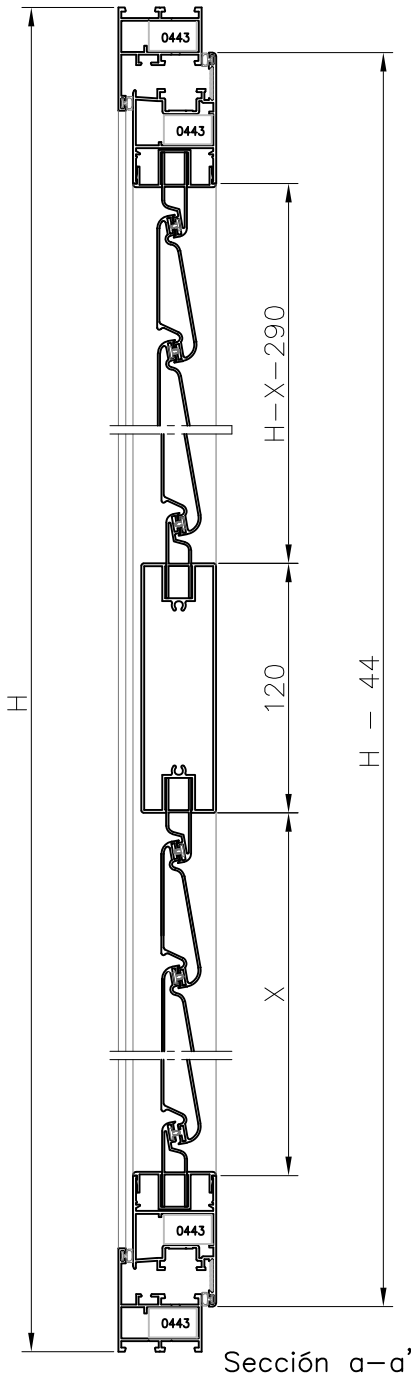



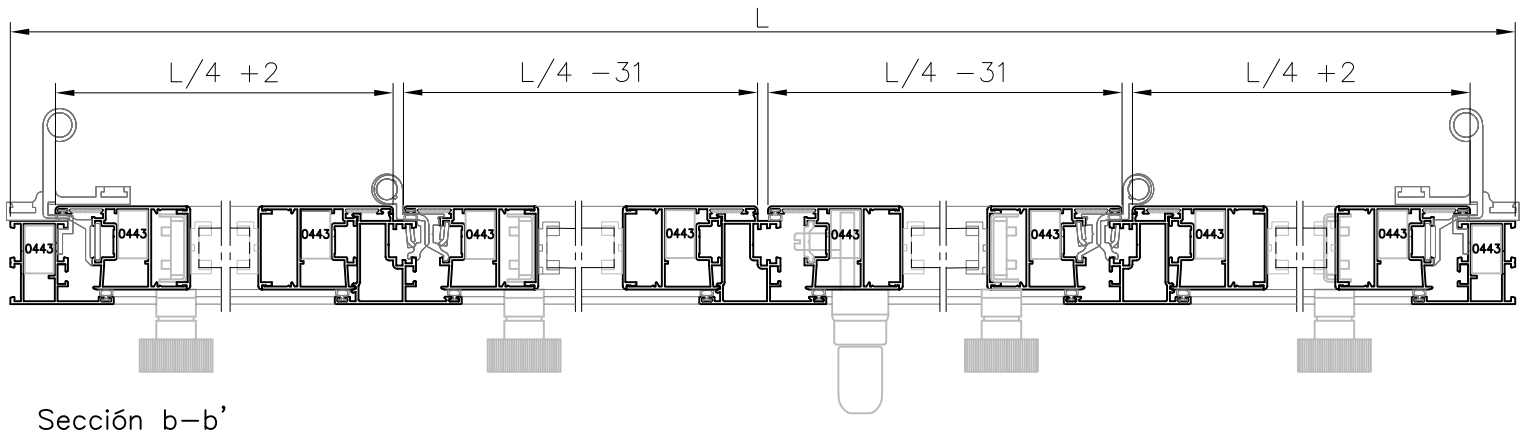
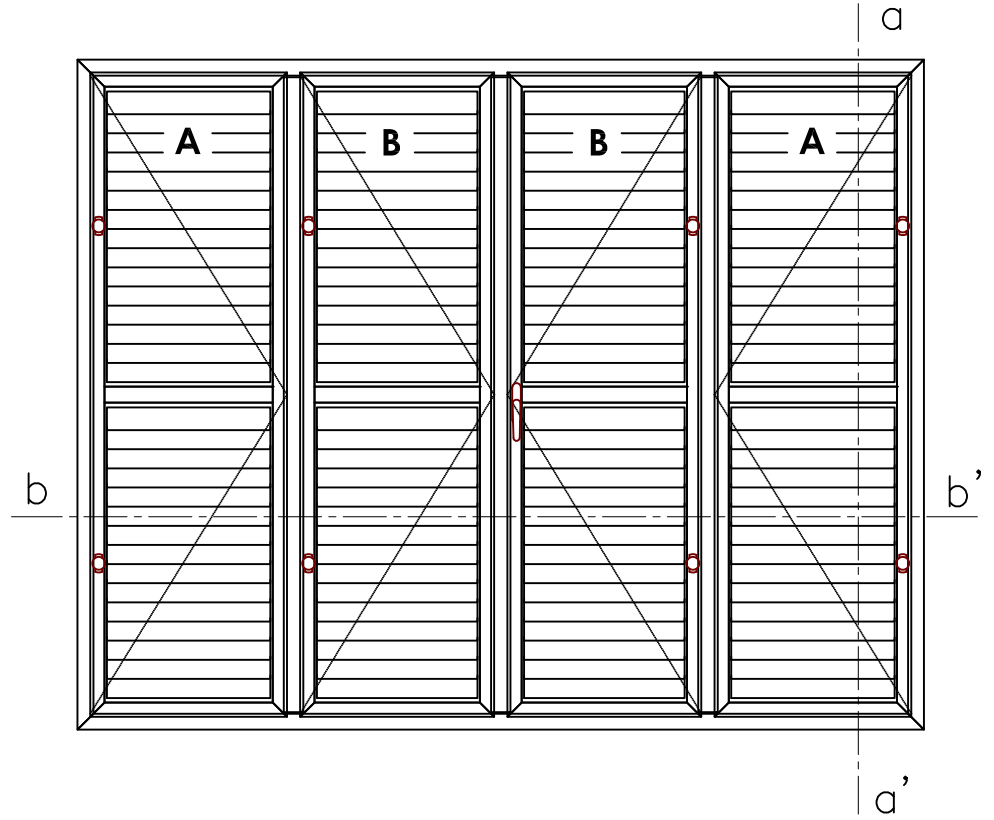







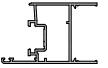



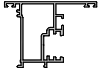





Sección a-a'



Sección b-b'

HOJA DE CORTE Y ACCESORIOS







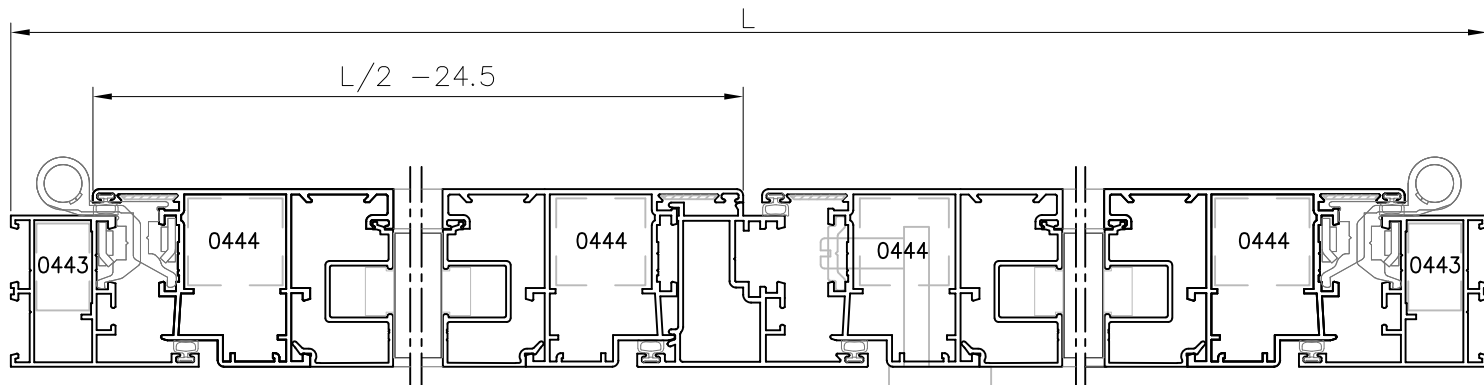
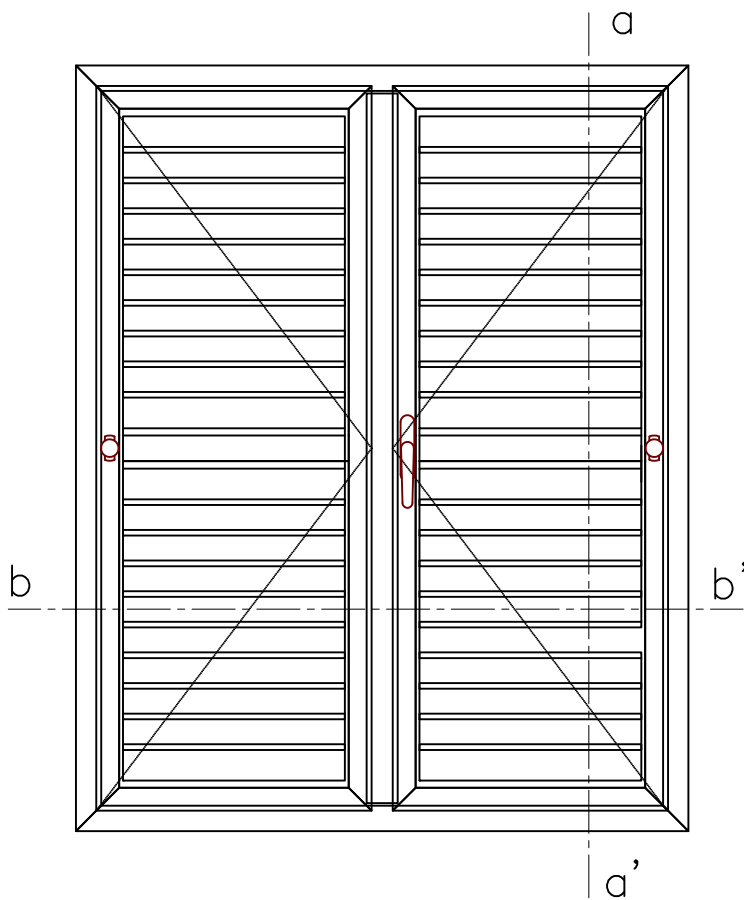
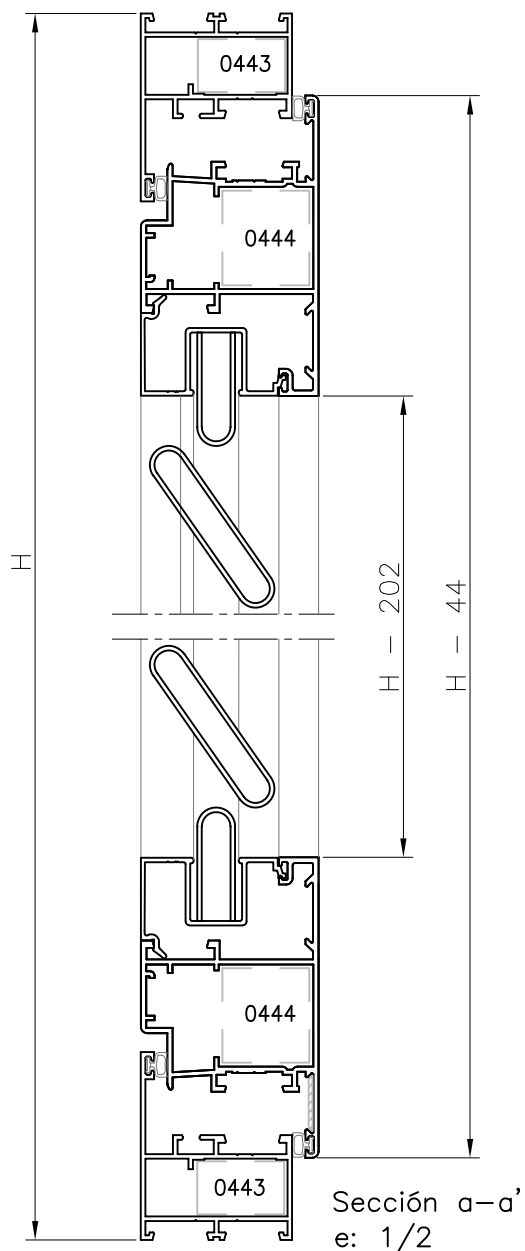





perfiles					
SECCIÓN	DESCRIPCIÓN	REFERENCIA	CORTE	MEDIDA	CANTIDAD
	cerco 15 mm	4101		L	2
				H	2
	hoja recta 15 mm	4201		A L/4 + 2	4
				B L/4 - 31	4
				H - 44	6
	inversor	4231		H - 110	3
	travesaño de 120 mm	4213		A L/4 - 90	2
				B L/4 - 123	2
	perfil base en U	4221		A L/4 - 128	4
				B L/4 - 161	4
	lama compensación de 57 mm	4222		A L/4 - 136	8
				B L/4 - 169	8
	lama orientable	4224		A L/4 - 136	según altura
				B L/4 - 169	

accesorios		
DESCRIPCIÓN	REFERENCIA	CANTIDAD
escuadra cerco/hoja	0443	20
escuadra alineamiento hoja	1200	16
tapa inversor 4231	INE1903	3
mecanismo para lama móvil	ver tabla mecanismos	8
mando ROTARY negro ambas manos	9750	8

juntas		
DESCRIPCIÓN	REFERENCIA	CANTIDAD
junta estanqueidad burbuja	309.043.TP	2 L 13 H
junta lama orientable	331.050.C1	según nº lamas



HOJA DE CORTE Y ACCESORIOS

perfiles					
SECCIÓN	DESCRIPCIÓN	REFERENCIA	CORTE	MEDIDA	CANTIDAD
	cerco 15 mm	4101		L	2
				H	2
	hoja recta 27 mm ap.ext.	4021		L/2 - 24.5	4
				H - 44	4
	inversor	4231		H - 110	1
	reductor para lama fija	P40906		L/2 - 139	4
				H - 158	4
	lama fija ovalada	4223		L/2 - 185	según altura

accesorios		
DESCRIPCIÓN	REFERENCIA	CANTIDAD
escuadra cerco	0443	4
escuadra hoja	0444	8
escuadra alineamiento hoja	1200	8
tapa inversor 4231	INE1903	1
soporte lama fija	0007	según altura

juntas		
DESCRIPCIÓN	REFERENCIA	CANTIDAD
junta estanqueidad burbuja	309.043.TP	4L 7H

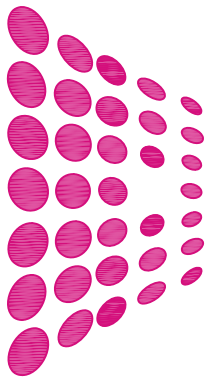

ROMINIO

Servicios y Suministros, S.L.U.

Catálogo de sistema

Central
C/ Albatros, 21
Polígono Industrial La Estación
28320 Pinto
Madrid

rominio@rominio.es
Teléfono 91 691 30 81
Fax 91 691 43 12

Delegación Ciudad Real
C/ Socuellamos, 11
Polígono Industrial Larache
13005 Ciudad Real
almacenciudadreal@rominio.es
Teléfono 926 214 548
Fax 926 213 731

www.rominio.es

RM40MN